



ELEGANCE

CORREDERA ELEVABLE - CATÁLOGO TÉCNICO

Carrer de l'Agricultura, 27
08840 Viladecans, BCN
93 637 75 12
alubaix@alubaix.com
www.alubaix.com

 @aluminiosdelbaix
@windthermic

4 **FICHA TÉCNICA**

6 **APERTURAS**

7 **RELACIÓN PERFILES**

11 **ACCESORIOS**

13 **PERFILES**

20 **ACRISTALAMIENTO**

21 **SECCIONES**

38 **HOJA DE CORTE**

ELEGANCE

La nueva versión recta de este sistema aporta una estética actual y elegante en línea con las últimas tendencias en arquitectura. Permite realizar composiciones de múltiples hojas, opciones de marco en versión perimetral completa, y posibilidad de marco reducido a testa y oculto con carril de aluminio reversible.

La corredera elevable Elegance permite el deslizamiento de hojas de gran tamaño que pueden alcanzar los 400 kg e instalar vidrios de hasta 42 mm de espesor. La hoja con junquillo garantiza la fácil instalación de los vidrios en obra.

Este diseño ha permitido mejorar sus prestaciones técnicas en los ensayos AEV, donde ha obtenido una clasificación de 4, 7A y C3.

En la apertura, las hojas se elevan ligeramente gracias a un mecanismo que permite su desplazamiento con suavidad y sin rozamientos. En posición cerrada, estas descansan sobre juntas de estanqueidad longitudinales que favorecen la hermeticidad. Posibilita el montaje de ventanas correderas de gran tamaño con costes reducidos.



¿POR QUÉ ESCOGER ELEGANCE?

- Diseñada para grandes espacios, pesos y dimensiones
- Herraje de cómodo manejo
- Versatilidad de marco y hojas
- Eficiencia y confort acústico

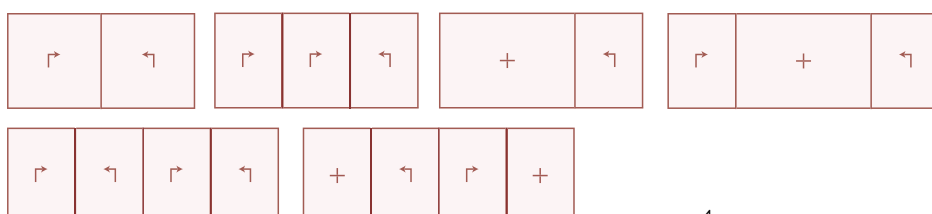

	Ventana	Balconera
 Permeabilidad al aire UNE-EN 1026:2017; UNE-EN 12207:2017	-	Clase v4
 Estanqueidad al agua UNE-EN 1027:2017; UNE-EN 12208:2000	-	7A
 Resistencia a la carga del viento UNE-EN 12211:2017; UNE-EN 12210:2017	-	C3
 Transmitancia térmica UW Balconera 1 hoja UNE-EN 10077-1:2017	-	Hasta 1.1W/m ² K
 Aislamiento acústico RW Ventana 2 hojas UNE-EN ISO 10140-2:2011	42 dB	-

Dimensiones y Peso máximo

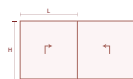

Recomendado para 1 hoja con herraje elevable y carro adicional.

 400Kg





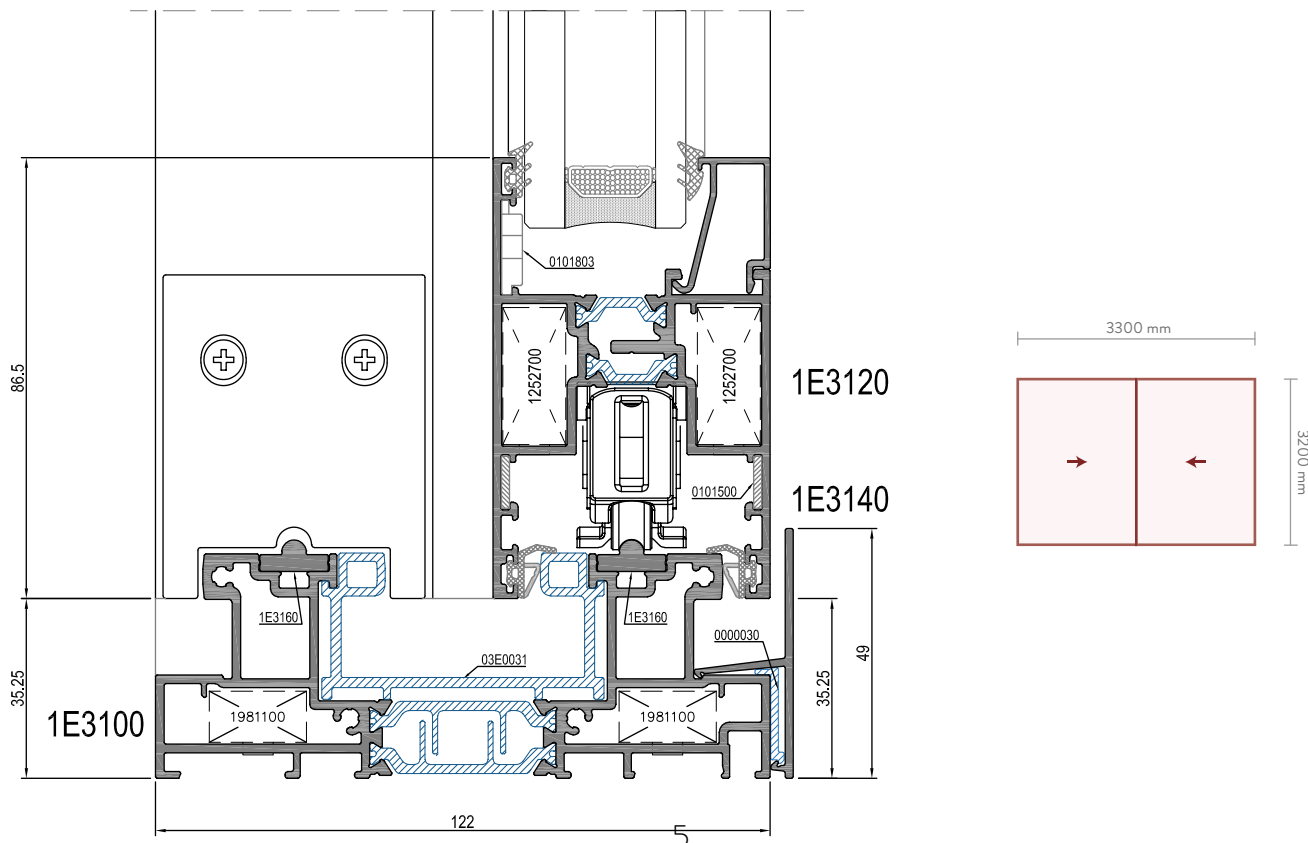

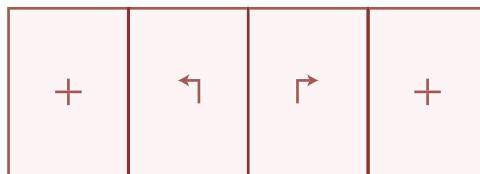
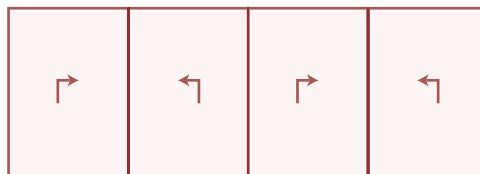
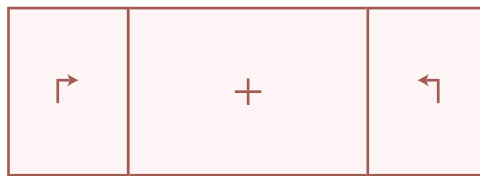
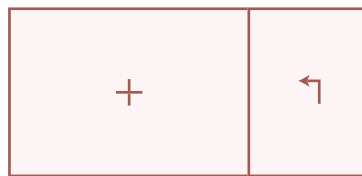
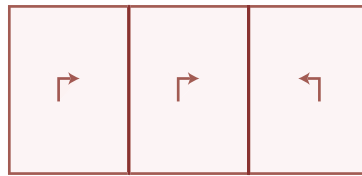
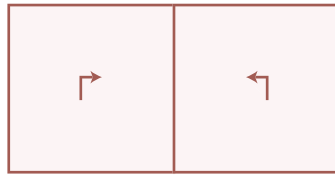



L
3300mm

H
3200mm















RELACIÓN DE PERFILES











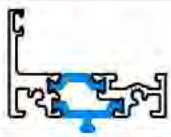

Referencia	Diseño	Descripción	Momentos Inercia	
			Lx (cm ⁴)	Ly(cm ⁴)
1E3100		marco perimetral	5.36	135.32
1E3110		marco recto	1.54	82.65
1E3113		marco fijo corredera	11.05	104.48
1E3115		marco perimetral tres carriles	20.89	443.88
1E3120		hoja perimetral	26.40	24.52
1E3125		marco recto tres carriles	2.17	275.37
1E3130		refuerzo hoja	2.63	6.16
1E3135		unión de 4 hojas	5.96	8.20
1E3165		cruce minimalista	5.96	8.20
1E3140		clip marco condensación	-	-

ELEGANCE







Referencia	Diseño	Descripción	Momentos Inercia	
			Lx (cm4)	Ly(cm4)
1E3150		clip para marco	0.34	2.37
1E3160		suplemento carril (recomendado plata anodizado)	-	-
1E3170		suplemento carril	-	-

Referencia	Diseño	Descripción	Peso (Gr/mt)	Perímetro Total(mm)
1E3100		marco perimetral	2230	1092
RPT-00826				
1E3110		marco recto	1420	755
RPT-00827				
1E3113		marco fijo corredera	1840	934.9
RPT-00887				
1E3115		marco perimetral tres carriles	3140	1637.4
RPT-00883				
1E3120		hoja perimetral	1661	748
RPT-00828				
1E3125		marco recto tres carriles	2079	1188
RPT-00884				
1E3130		unión de 4 hojas	822	407.1
RPT-00829				
1E3135		unión de 4 hojas	1057	499
RPT-00864				

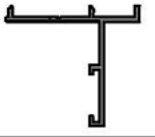





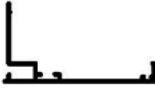



RELACIÓN DE PERFILES

1E3165		cruce minimalista	1168	367.2
RPT-00879				
1E3140		clip marco condensación	283	145
A-15559				
1E3150		clip para marco	483	218.3
A-15560				
1E3160		suplemento carril	153	37.3
A-15558				
1E3170		suplemento carril	499	204.4
A-16854				
12206		perfil de cruce	492	249
A-10901				
40505		junquillo de 4.5 mm.	210	103.1
CI-033-40505				
40508		junquillo de 8 mm.	239	147.7
CI-033-40508				
40512		junquillo de 12 mm.	232	146.25
CI-033-40512				
40515		junquillo de 15 mm.	236	148.24
CI-033-40515				
40517		junquillo de 17 mm.	234	151.05
CI-033-40517				
40519		junquillo de 19 mm.	269	170.07
CI-033-40519				



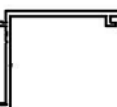
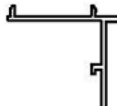





ELEGANCE



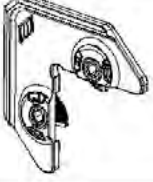

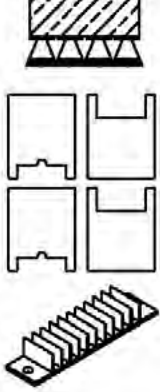
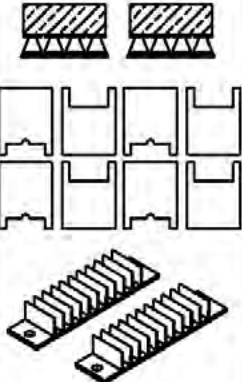
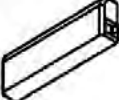



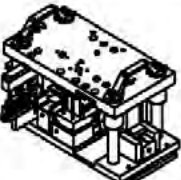



Referencia	Diseño	Descripción	Peso (Gr/mt)	Perímetro Total(mm)
40033		solape de 45 mm.	294	174.6
CI-033-40033				
40037		solape con bandeja de condensación	293	170.5
CI-033-40037				
00123		vierteaguas 58.2 mm.	305	178.99
CI-026-00123				
00122		vierteaguas 68.2 mm.	337	198.42
CI-026-00122				
40082		vierteaguas 100 mm.	454	266.4
CI-033-40082				
GP01944		guia de persiana con pala de 60 mm.		
REC4141		tapajuntas reg. pers. de 40 mm.		
REC6035		tapajuntas reg. pers. de 57 mm.		
REC8533		tapajuntas reg. pers. de 82 mm.		

RELACIÓN DE PERFILES

Referencia	Diseño	Descripción	Peso (Gr/mt)	Perímetro Total(mm)
40522		junquillo de 22 mm.	279	175.52
CI-033-40522				
40525		junquillo de 25 mm.	286	181.83
CI-033-40525				
40527		junquillo de 27 mm.	295	185.81
CI-033-40527				
40532		junquillo de 32 mm.	329	195.3
CI-033-40532				
40537		Junquillo de 37 mm.	327	206.07
CI-033-40537				
40030		solape de 30 mm.	240	144.4
CI-033-40030				
40033		solape de 45 mm.	294	174.6
CI-033-40033				
40037		solape con bandeja de condensación	293	170.5
CI-033-40037				
00123		vierteaguas 58.2 mm.	305	178.99
CI-026-00123				
00122		vierteaguas 68.2 mm.	337	198.42
CI-026-00122				
40082		vierteaguas 100 mm.	454	266.4
CI-033-40082				

ELEGANCE

1252700  Escuadra 26.9 x 12.5	1981100  Escuadra 20 x 11	0101500  Escuadra Alineamiento 5 x 1.6	0101803  escuadra de alineamiento exterior FUJI
0000030  Clip fijacion para perfil 1E3140	03E0031  Perfil PVC U de marco	1770022  Kit elevable Elegance 2 Hojas	1770023  Kit elevable Elegance 3 Hojas
302264  Tapa salida de agua	1882308  Clip cruce minimalista		
0000020  Guiador superior	0000050  Calzo Elegance fijo	0000060  Tapa 4 Hojas Elegance	

<p>03E0032</p>  <p>Junta hoja elevable</p>	<p>P2155</p>  <p>Junta exterior acristalar 2.5 mm</p>	<p>0304010</p>  <p>Junta Interior hoja Junta exterior acristalar</p>	<p>B510</p>  <p>Junta acrist. inte. 3 mm.</p>
<p>B512</p>  <p>Junta acrist. Inte. 4 mm.</p>	<p>B514</p>  <p>Junta acrist. Inte. 5 mm.</p>	<p>B516</p>  <p>Junta acrist. Inte. 6/7 mm.</p>	<p>B518</p>  <p>Junta acrist. Inte. 8/9 mm.</p>
<p>B520</p>  <p>Junta acrist. inte. 10 mm.</p>	<p>P2776</p>  <p>Perfil EPDM de cruce</p>	<p>0106575</p>  <p>Felpa tres láminas hojas 6.5x7.5 negro</p>	<p>0105075</p>  <p>Felpa de cruce minimalista con film</p>

ELEGANCE

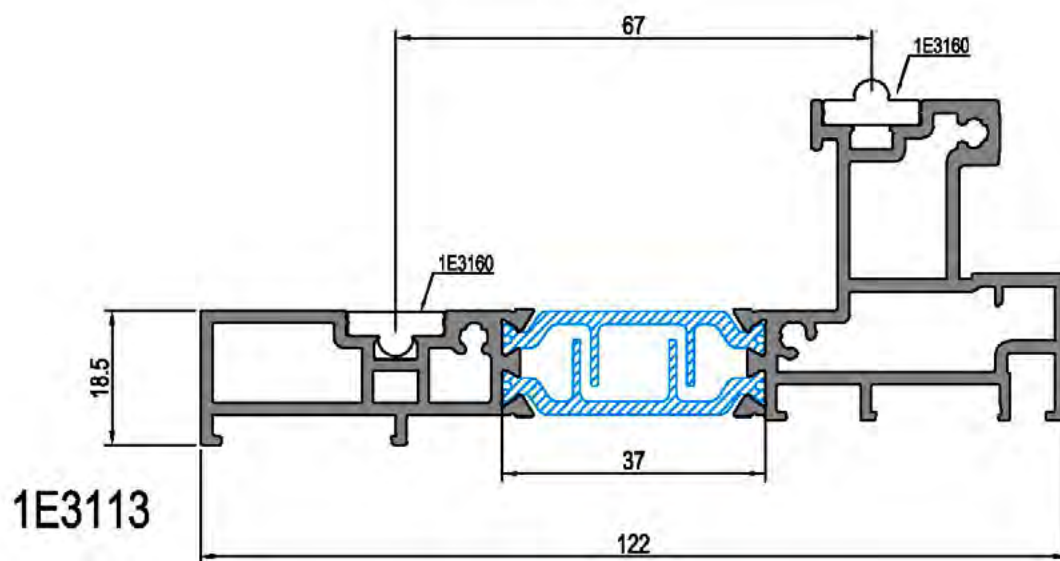
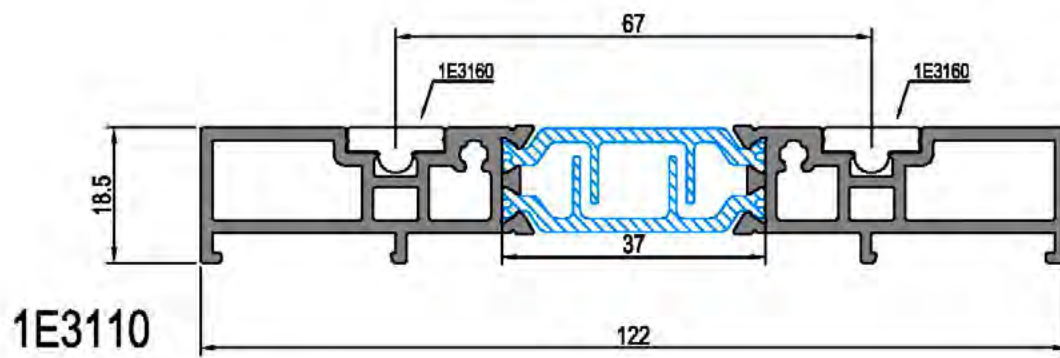
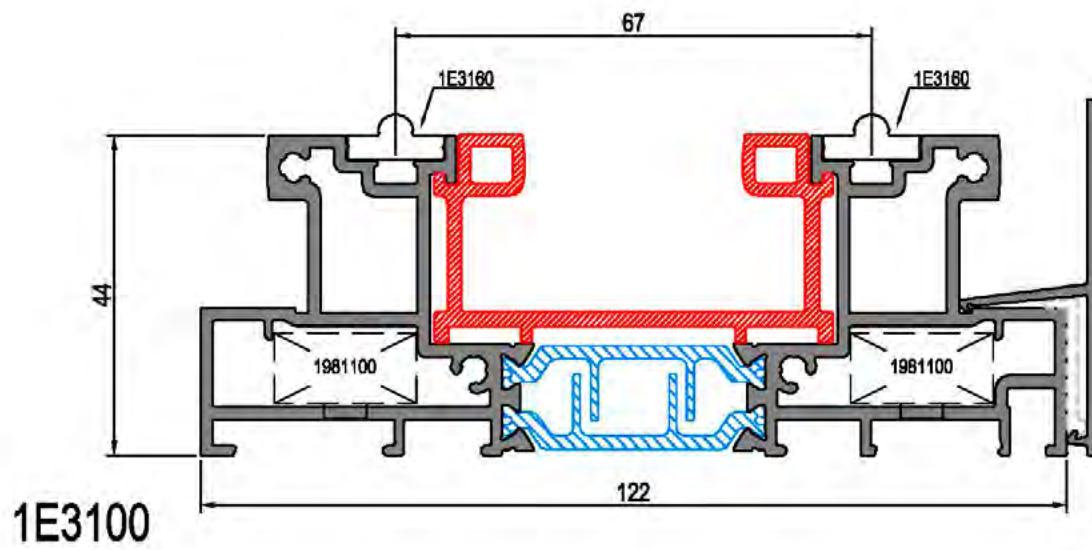

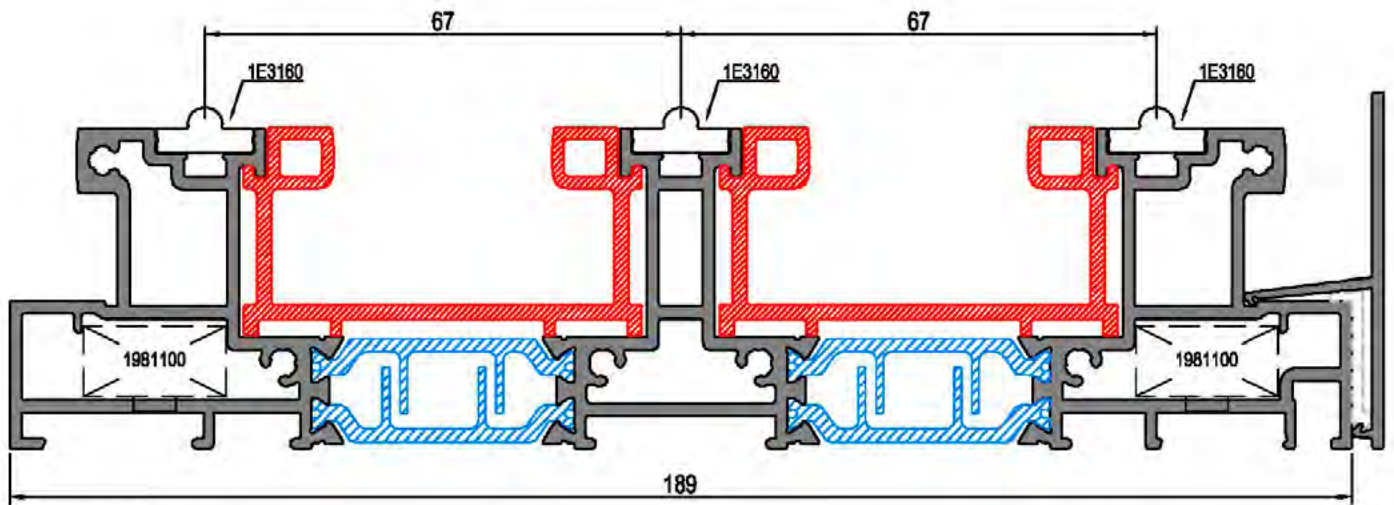

1E3115

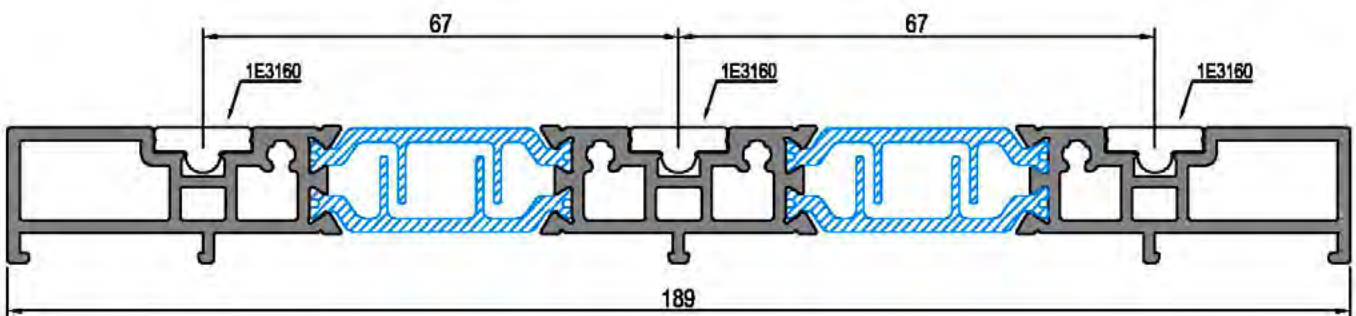

1E3125

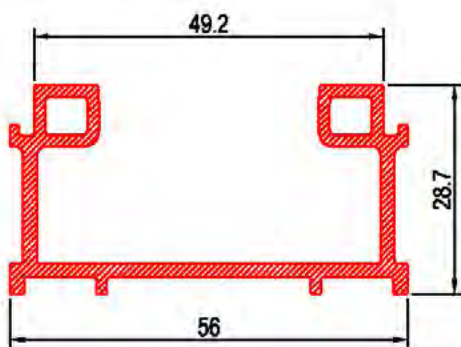

03E0031

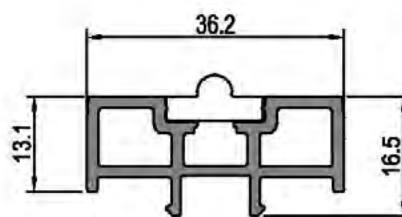

1E3150

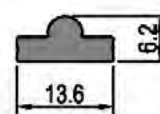

1E3160

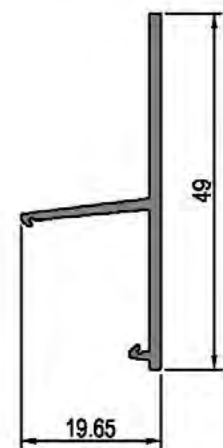

1E3140

ELEGANCE

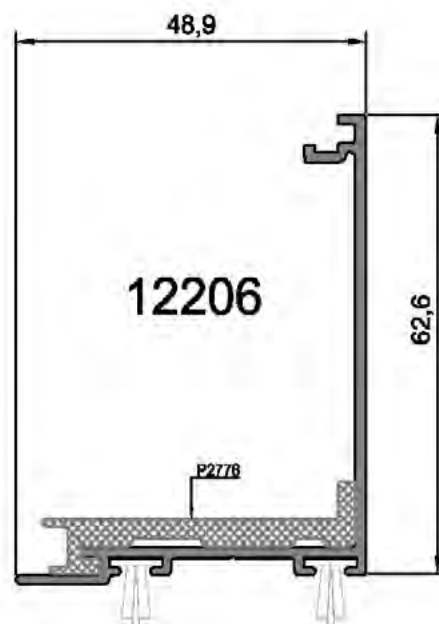
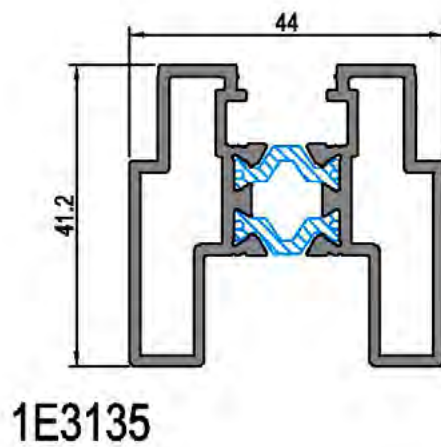
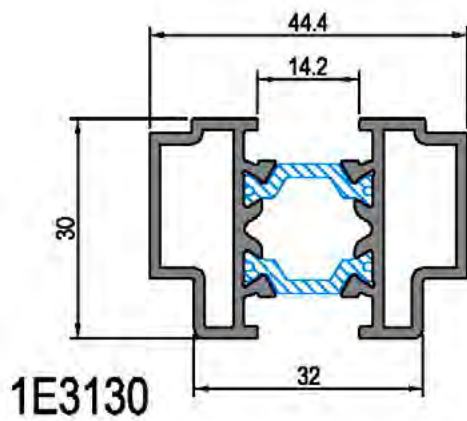
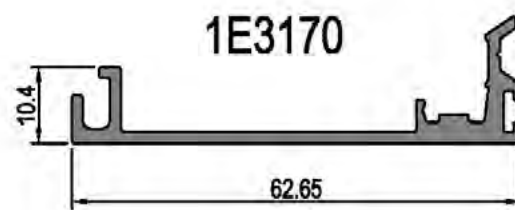
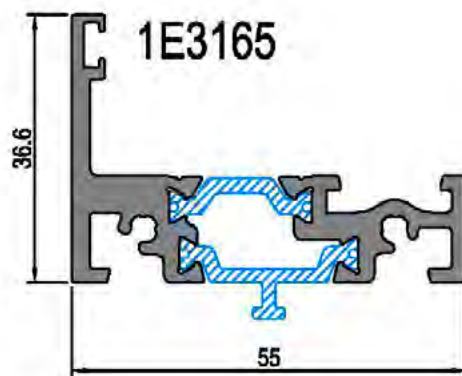
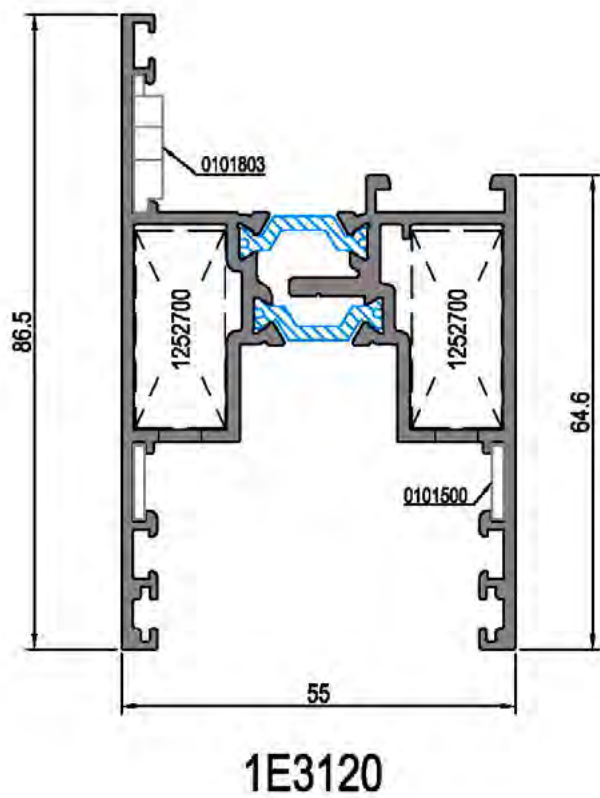

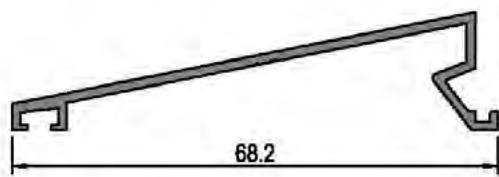
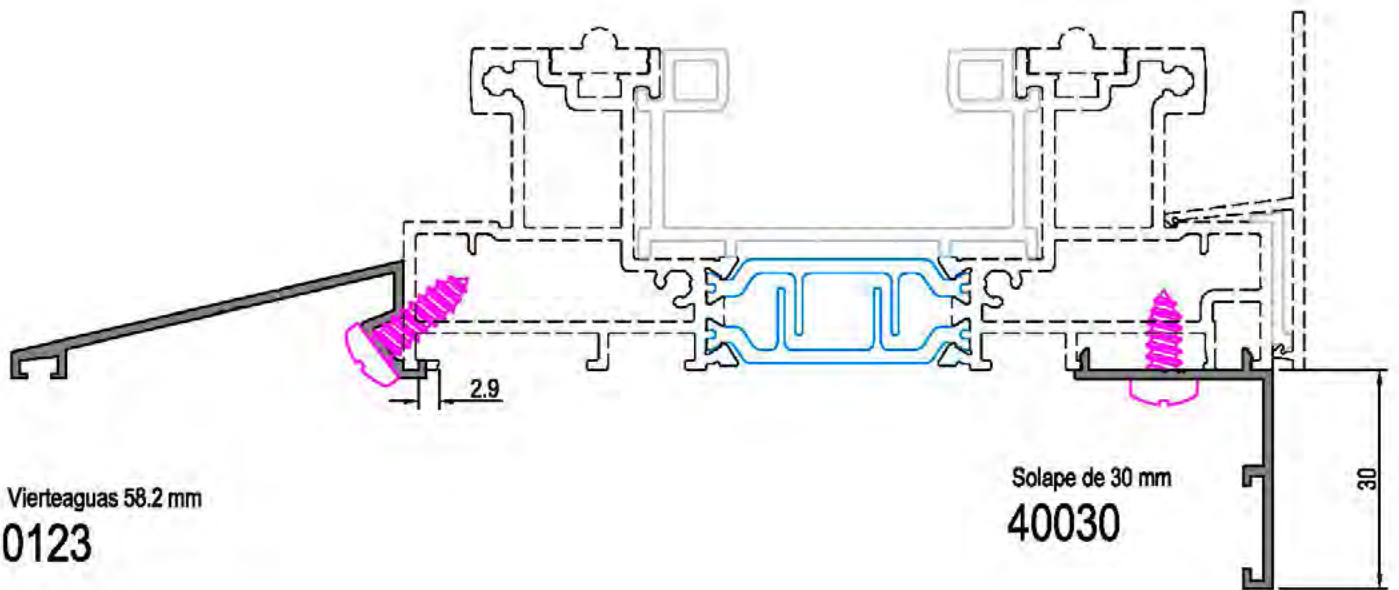

Vierteaguas 68.2 mm
0122

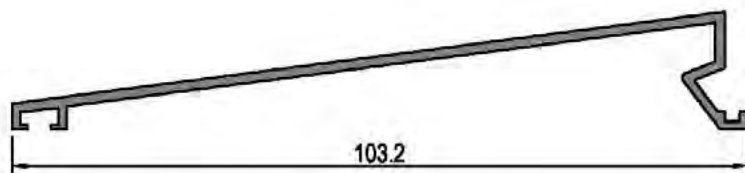
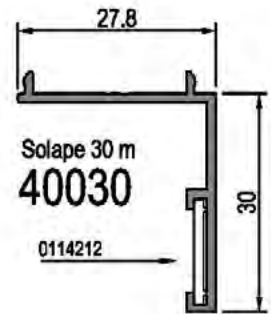

Vierteaguas 100 mm
40082



ELEGANCE

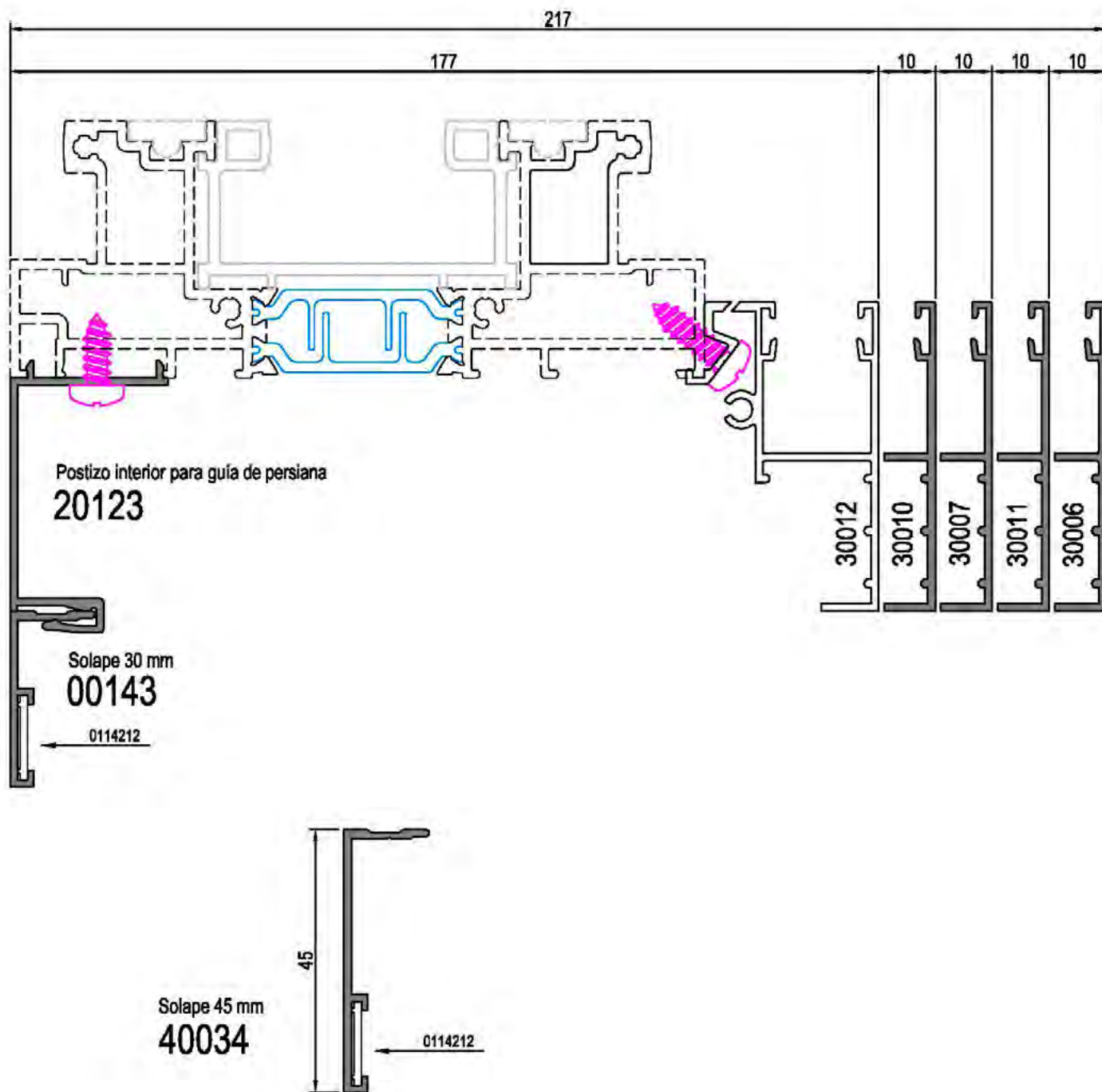

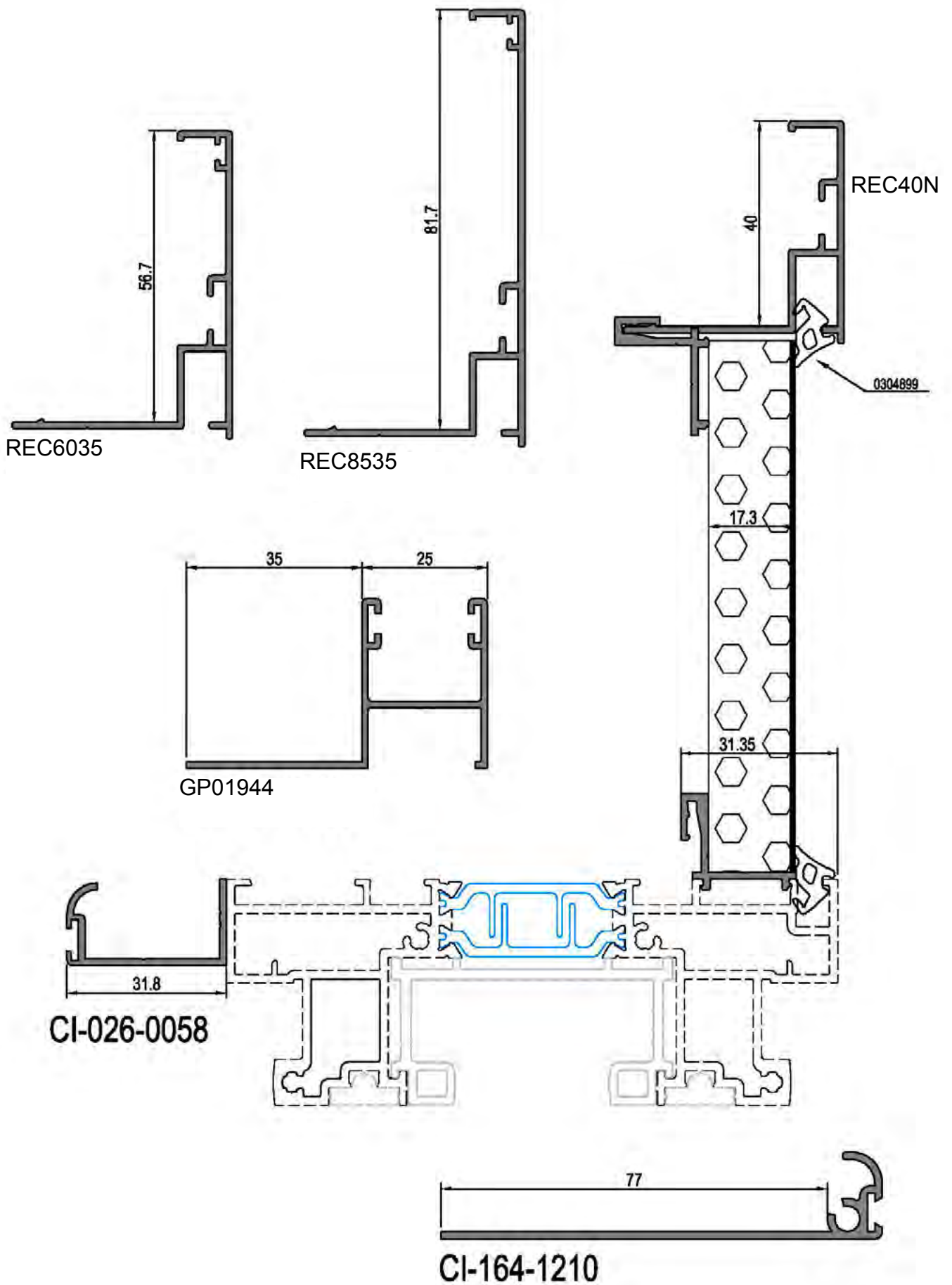

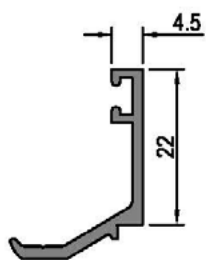

Junquillo 4,5 mm
40505

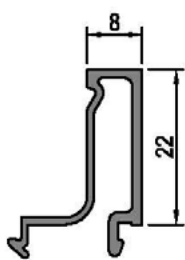

Junquillo 8 mm
40508

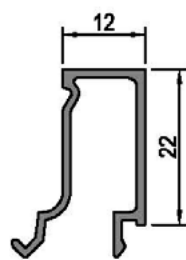

Junquillo 12 mm
40512

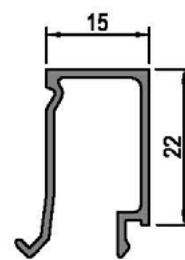

Junquillo 15 mm
40515

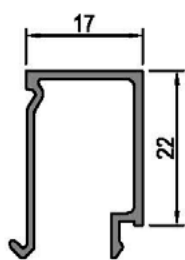

Junquillo 17 mm
40517

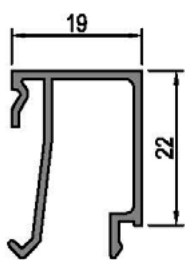

Junquillo 19 mm
40519

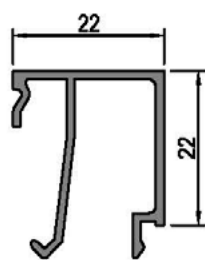

Junquillo 22 mm
40522

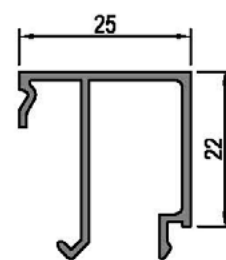

Junquillo 25 mm
40525

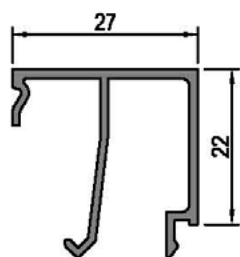



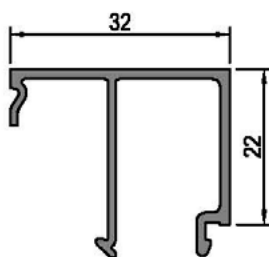



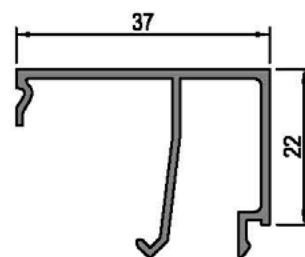

Junquillo 27 mm
40527



Junquillo 32 mm
40532



Junquillo 37 mm
40537

EXTERIOR			
	0304001 3 mm	P2155 2,5 mm	
INTERIORES			
	304896 2,5 a 3,5 mm	304897 3,5 a 4,5 mm	304898 4,5 a 5,5 mm
			
	304899 6 a 8 mm	304890 8 a 9 mm	304891 10 mm

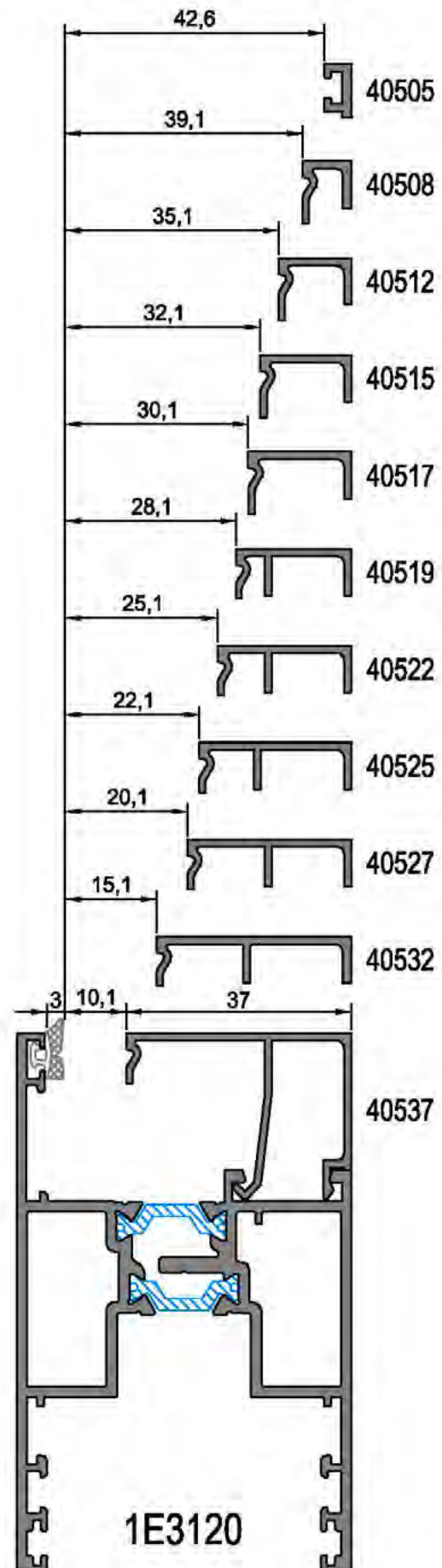

SITUACIÓN RECOMENDADA DE LOS CALZOS DE ACRISTALAMIENTO

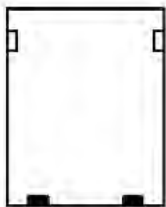

BASTIDOR FIJO

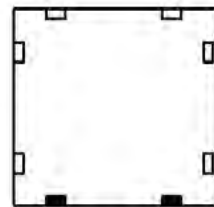

BASTIDOR DESLIZANTE-ELEVABLE

Nota:
Los calzos deben colocarse sobre los ejes del carro de deslizamiento.

Nomenclaturas de los calzos

- Calzo de apoyo
- Calzo de colocación

Notas:

- Los calzos deben colocarse según los croquis arriba indicados.
- La distancia entre el eje del calzo y el borde del vidrio será de $L/10$, siendo L la longitud del lado donde se emplazan.

ELEGANCE

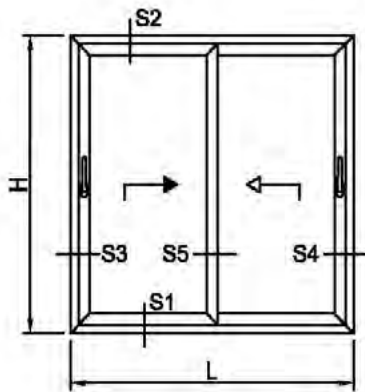

SECCIÓN 1

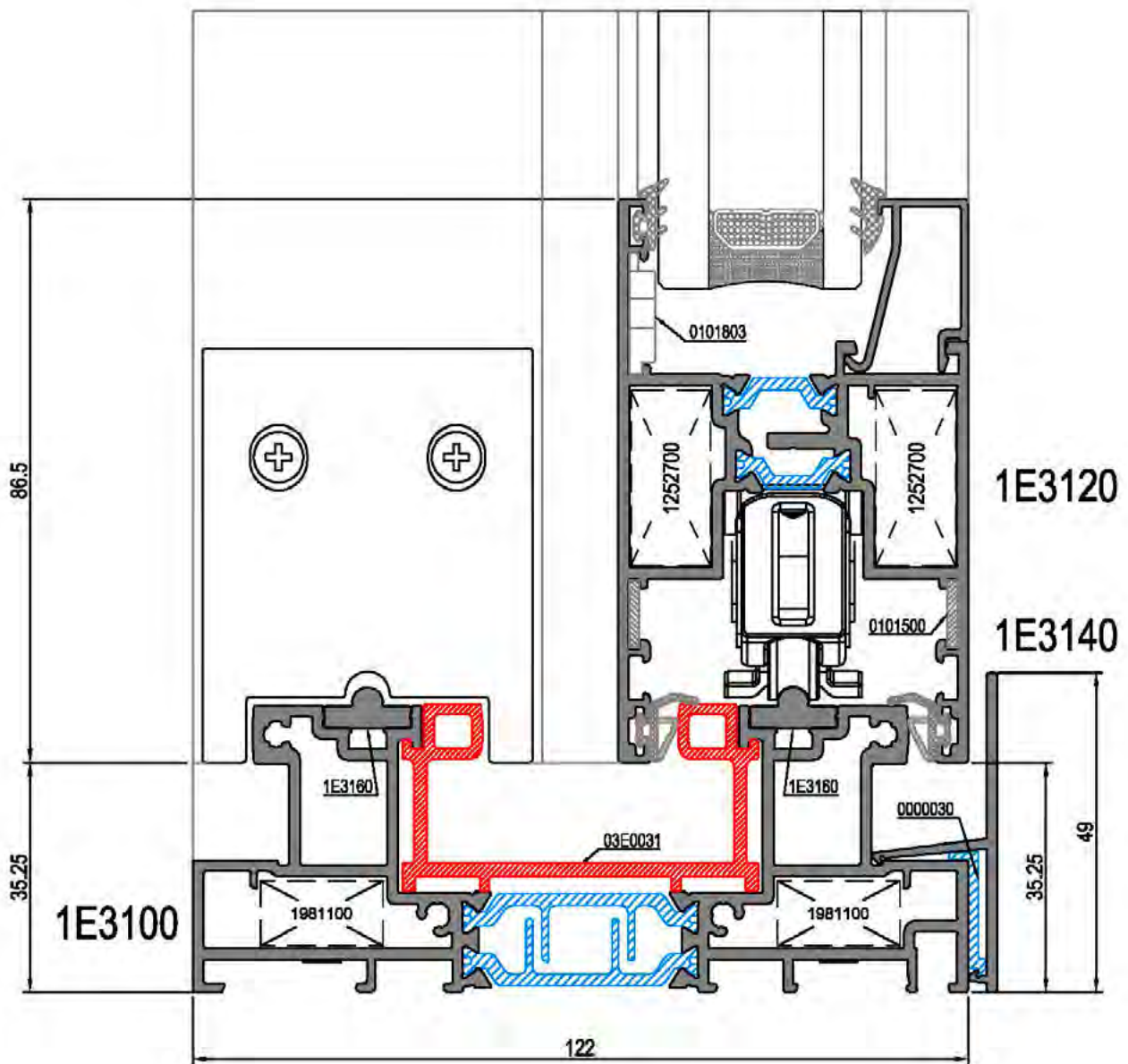

Escala 1:1

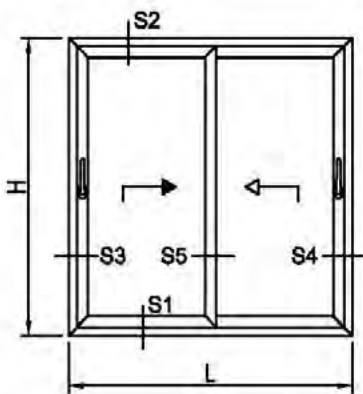

SECCIÓN 2

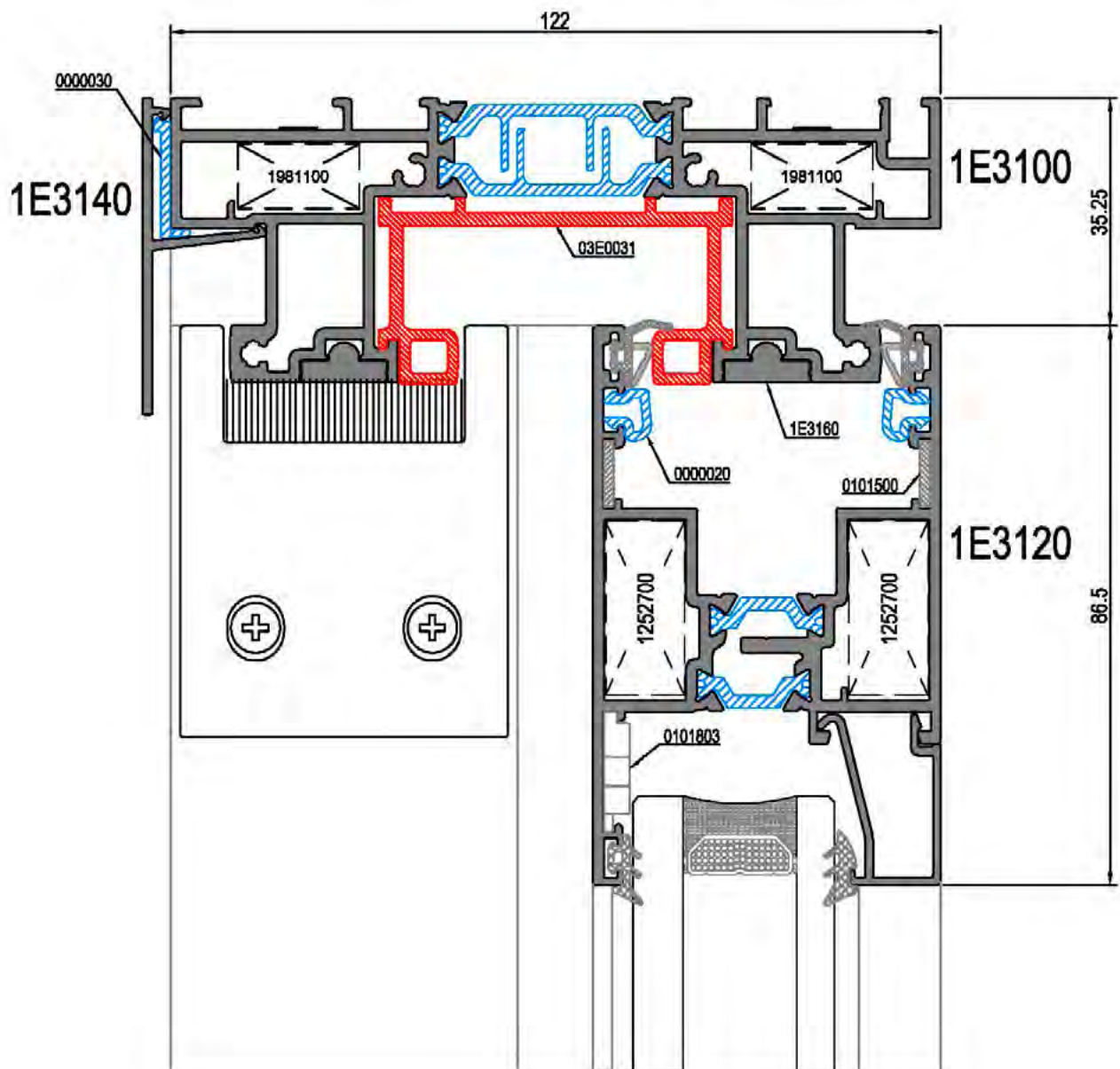

Escala 1:1

ELEGANCE

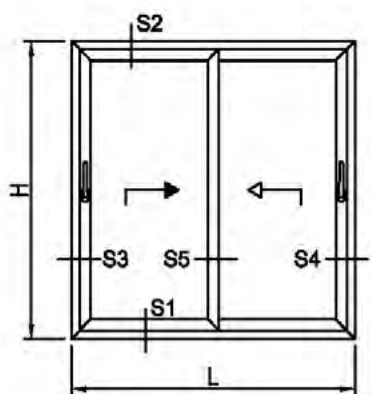

SECCIÓN 3

1E3100

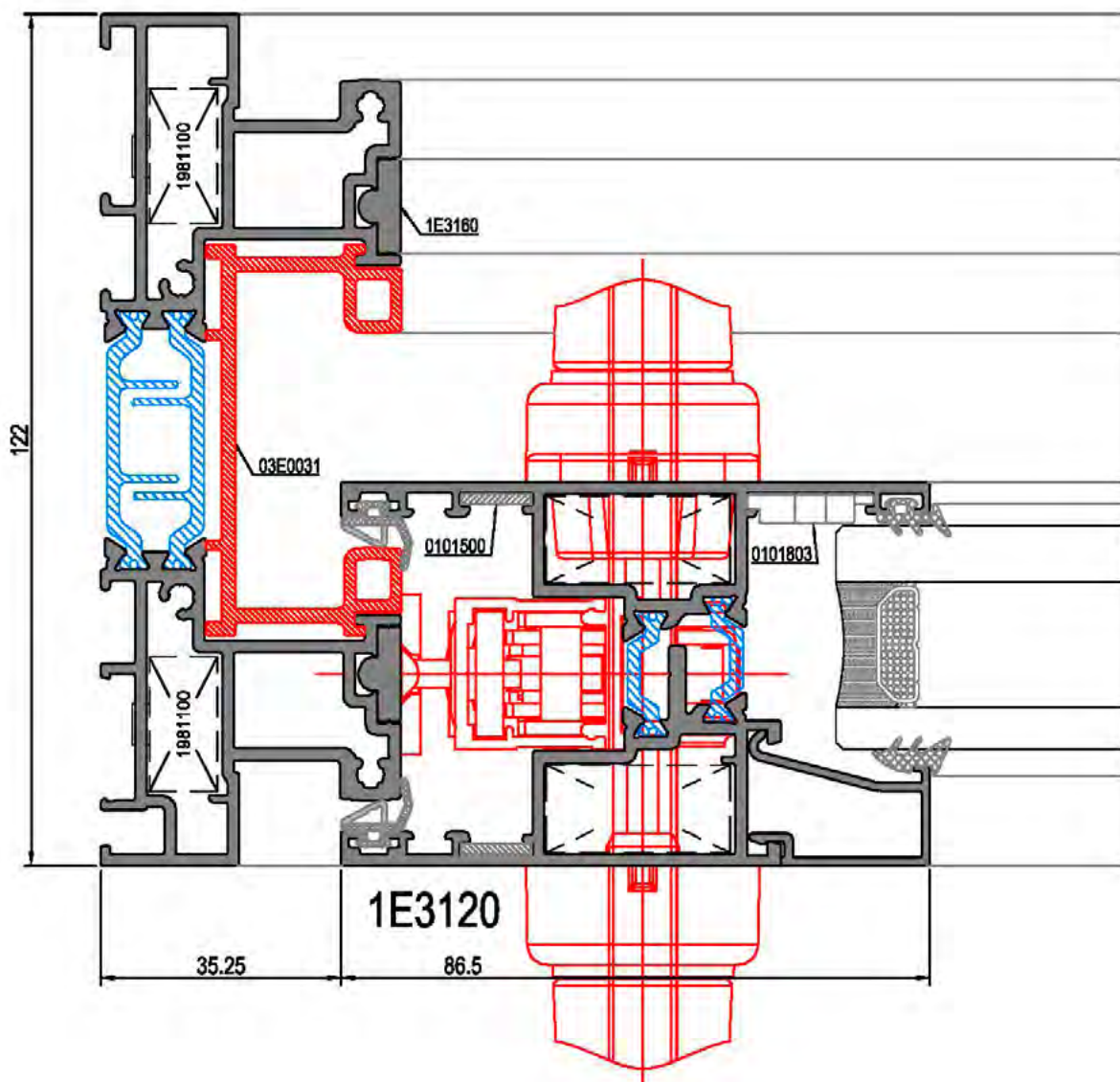

Escala 1:1

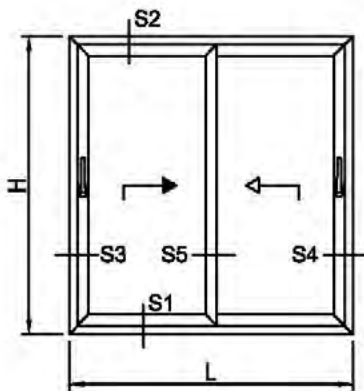

SECCIÓN 4

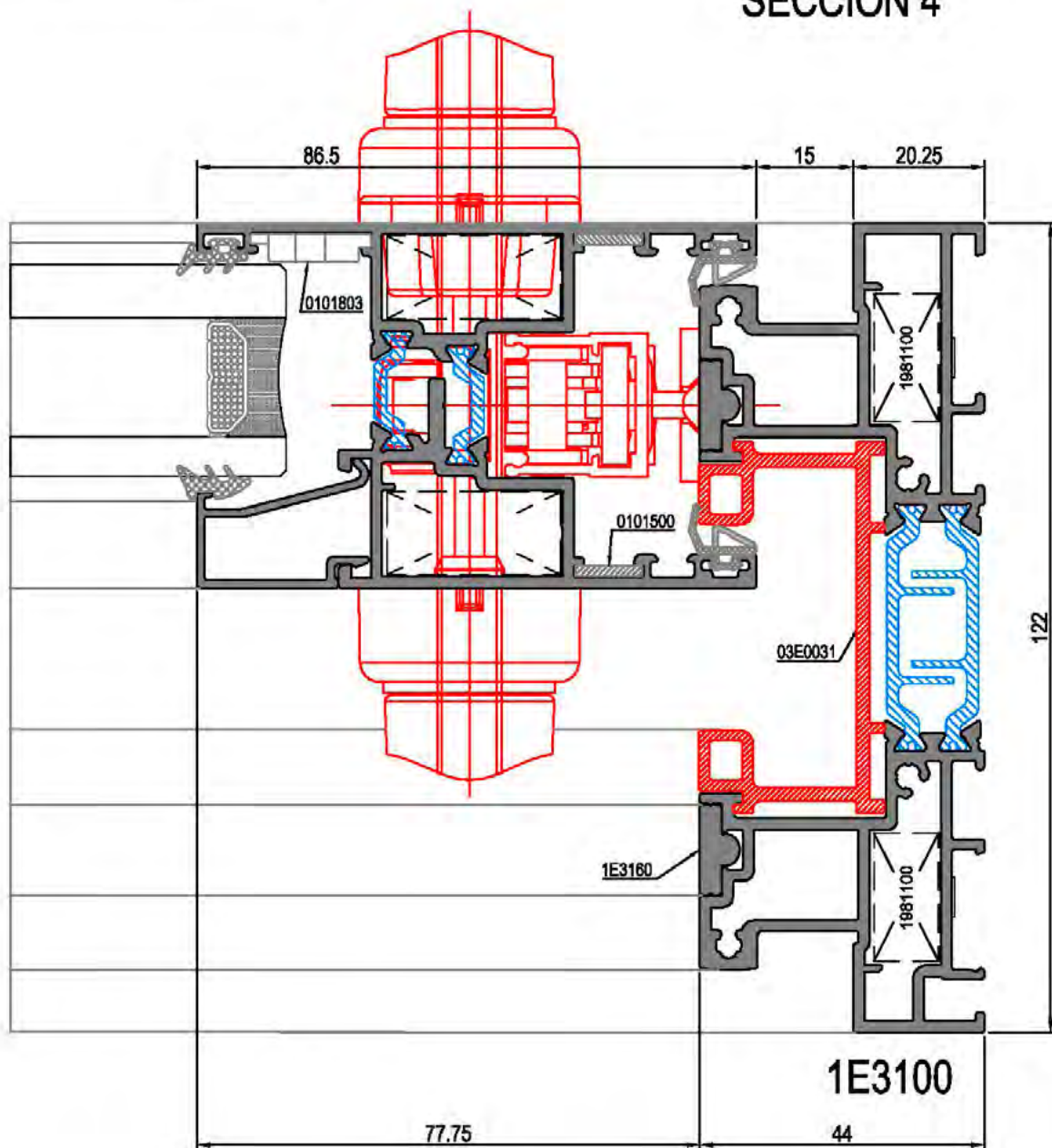

Escala 1:1

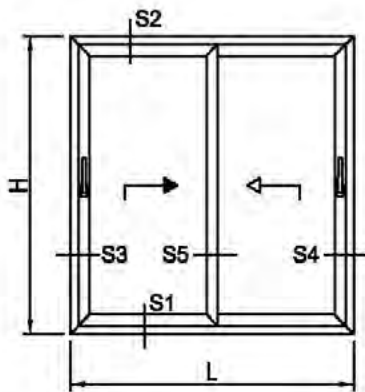

SECCIÓN 5

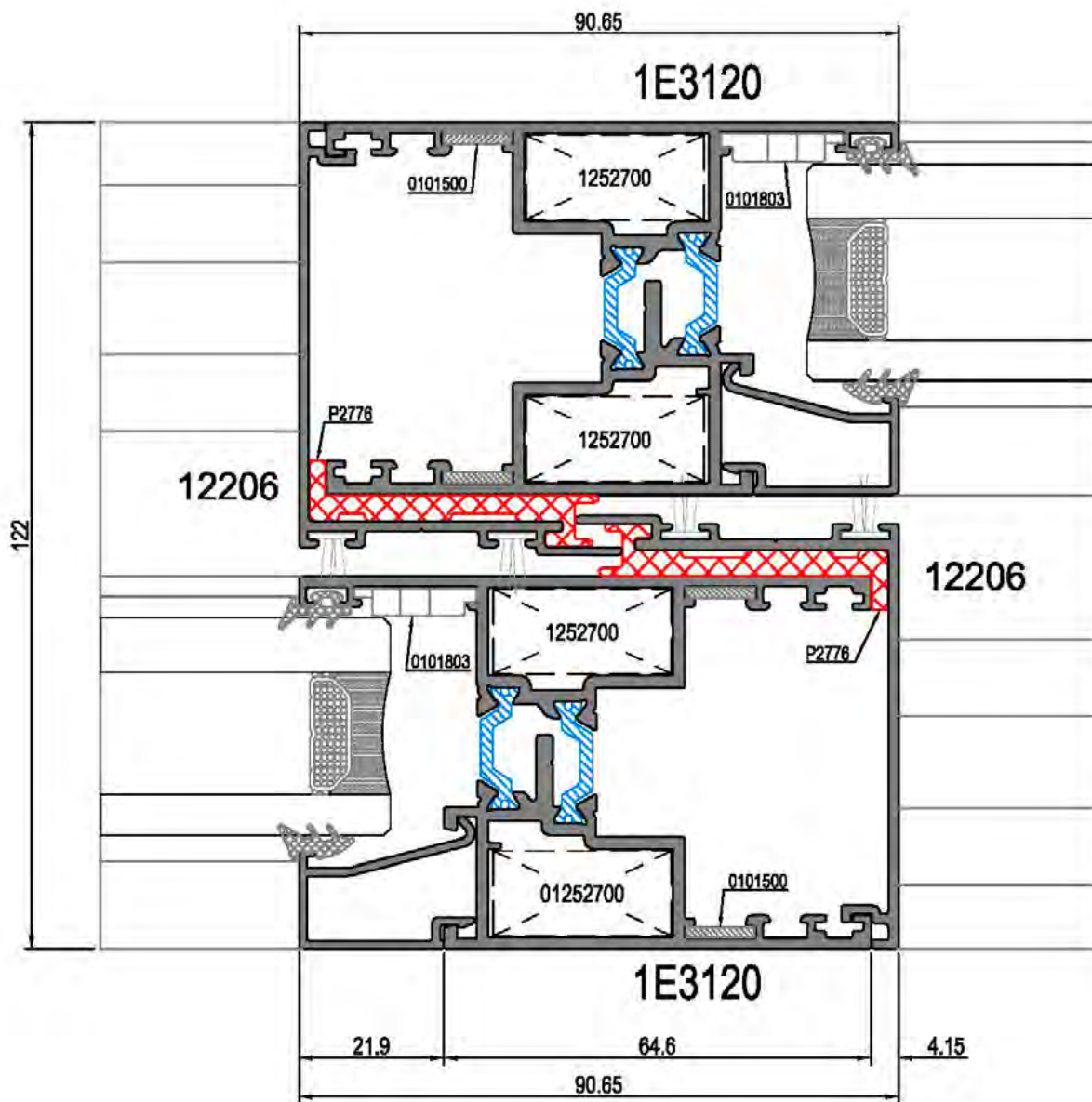

Escala 1:1

ELEGANCE

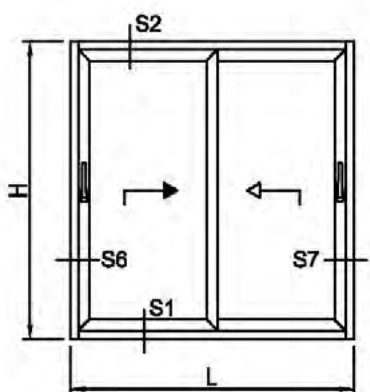

SECCIÓN 6

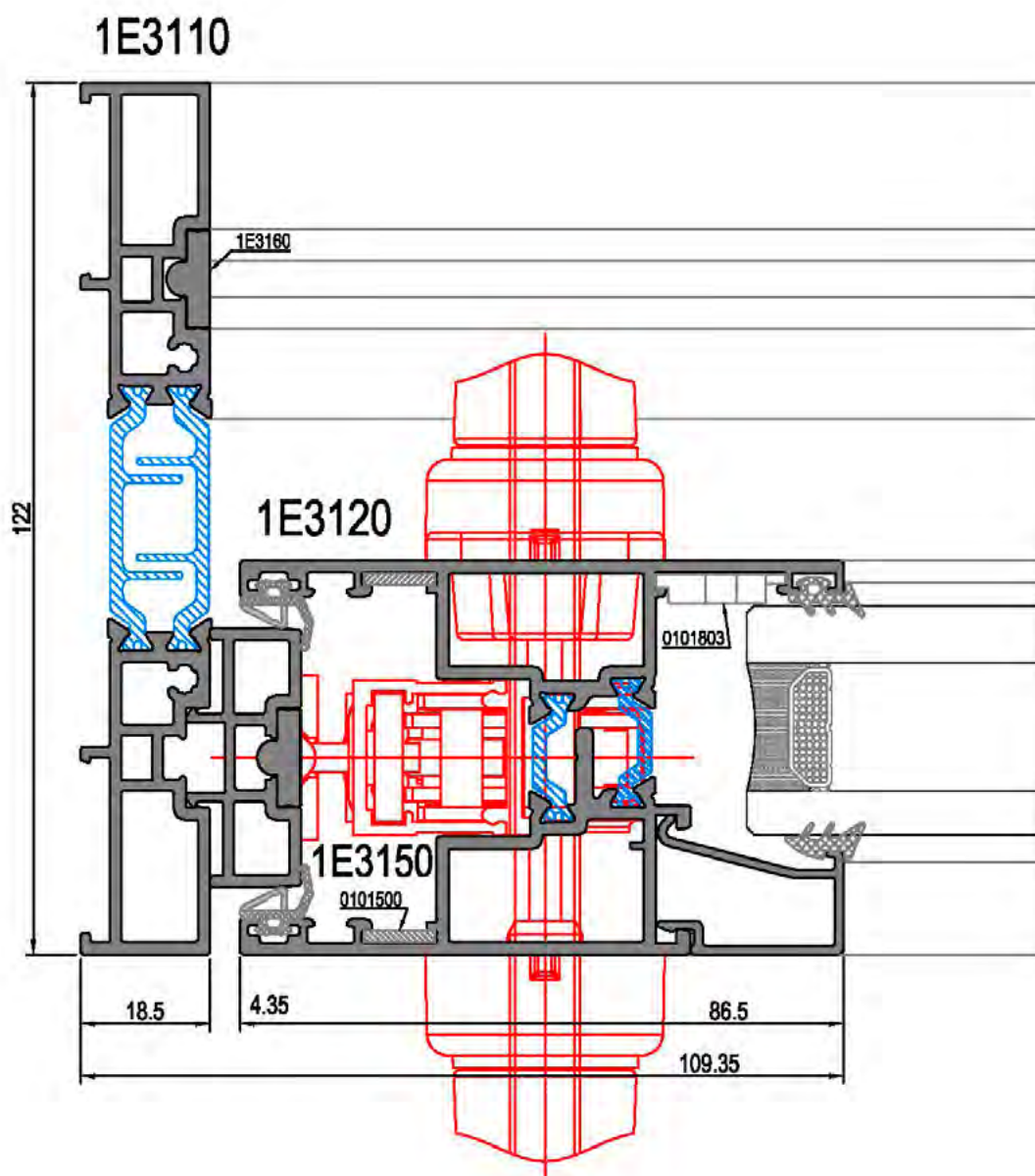

Escala 1:1

ELEGANCE

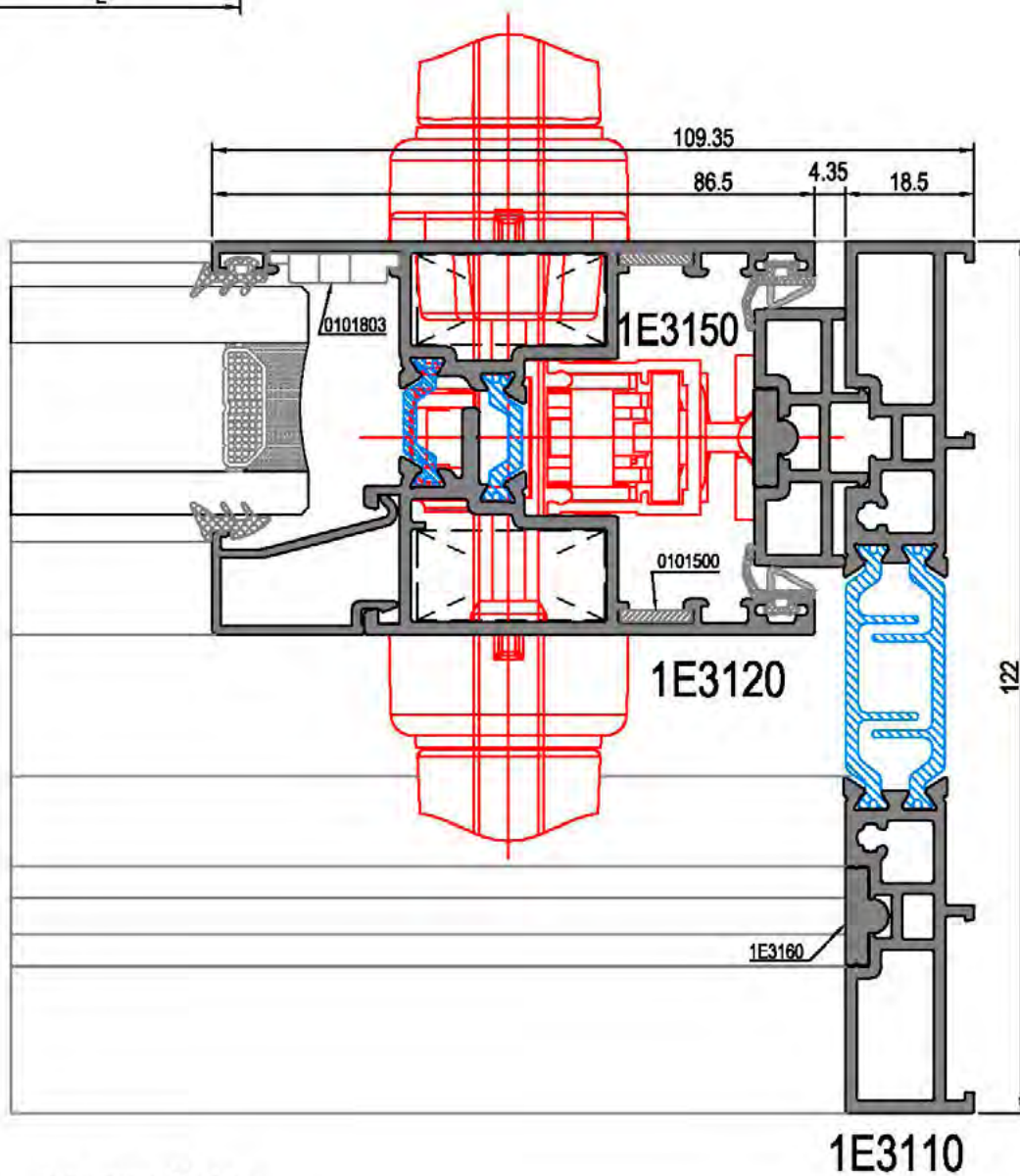
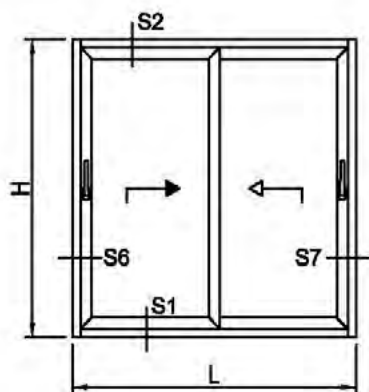

SECCIÓN 7

Escala 1:1

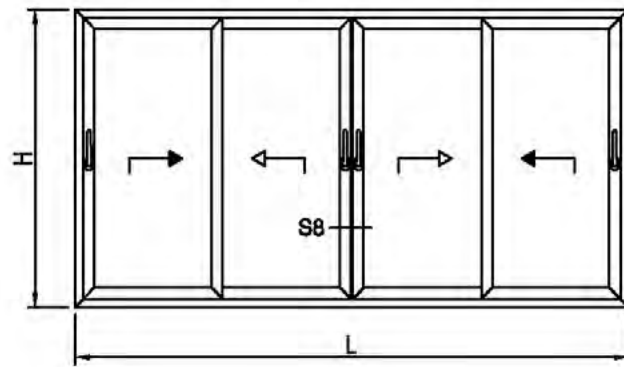

SECCIÓN 8

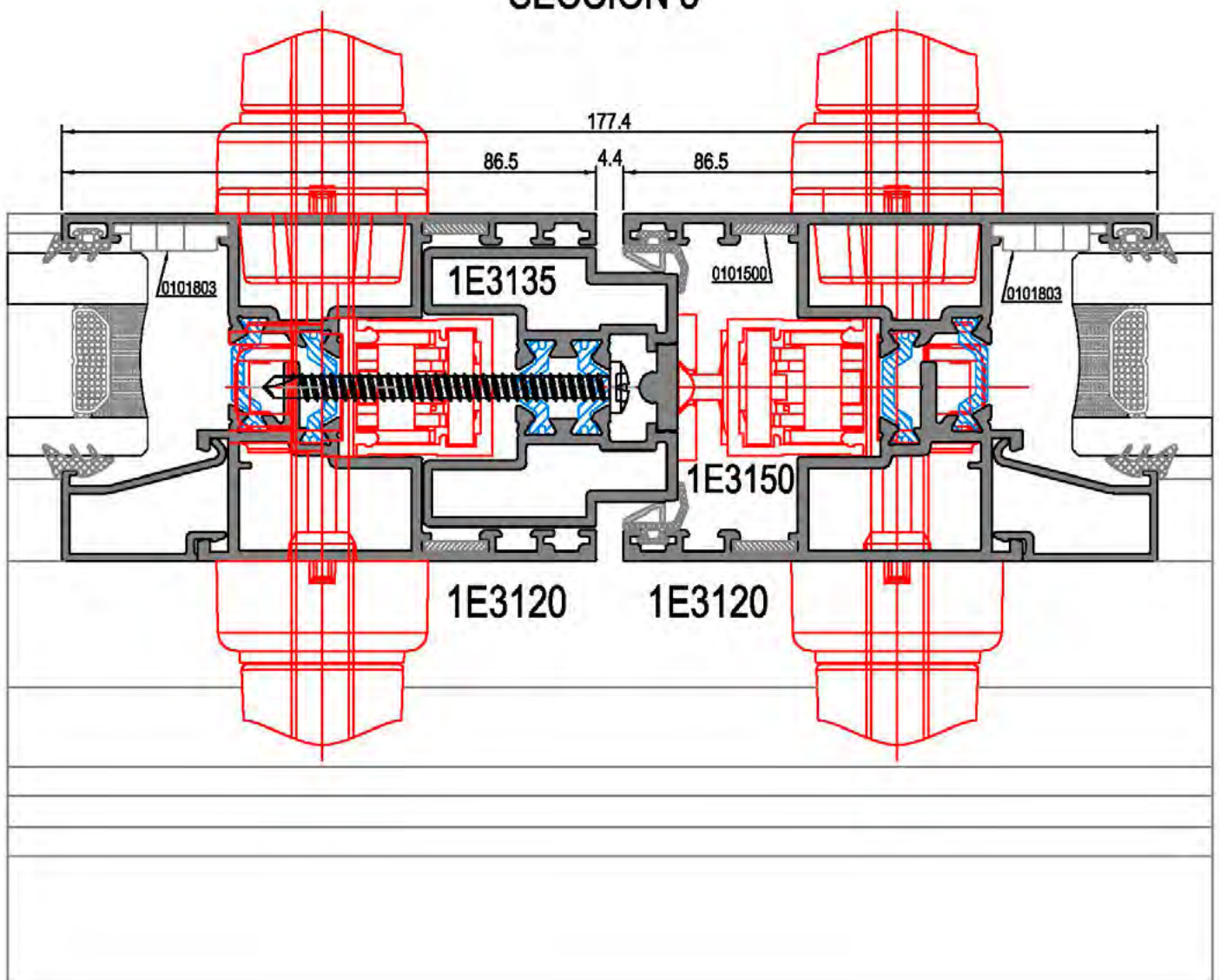

Escala 1:1

ELEGANCE

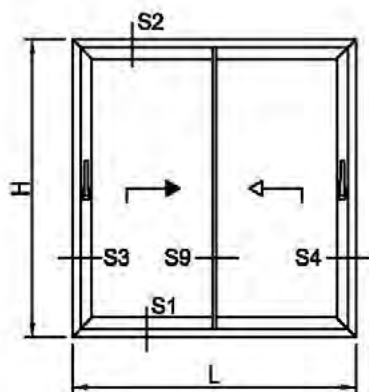

SECCIÓN 9

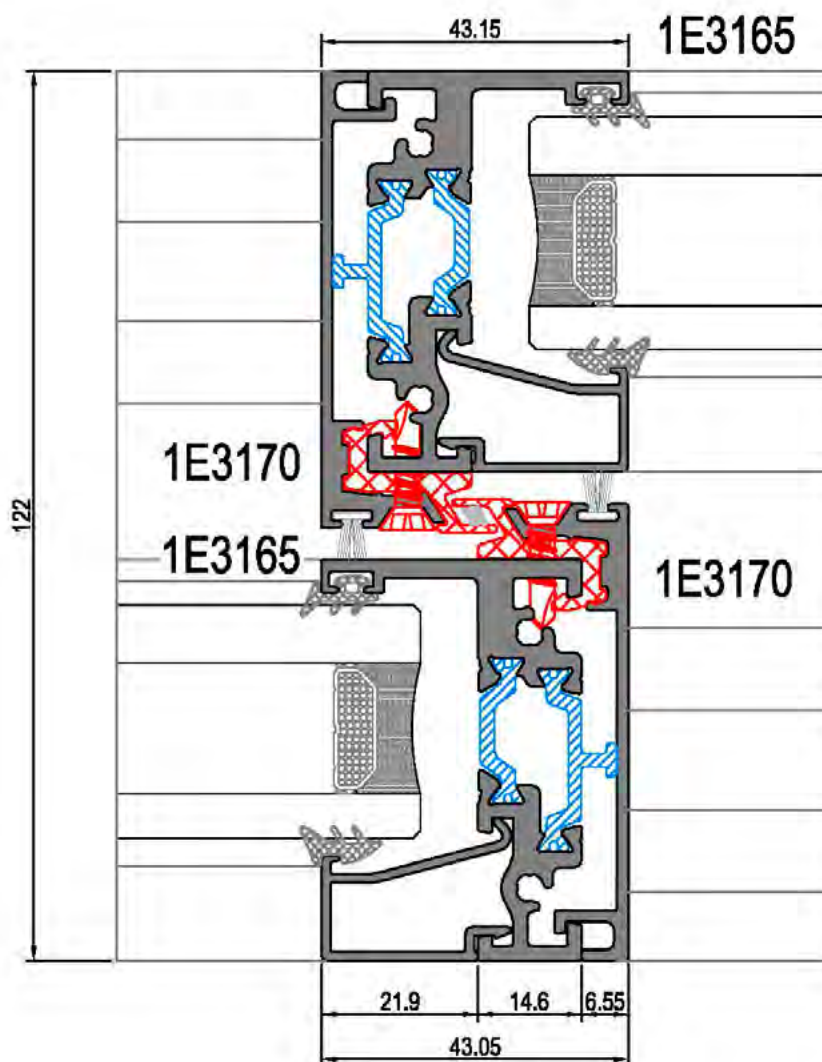

Escala 1:1

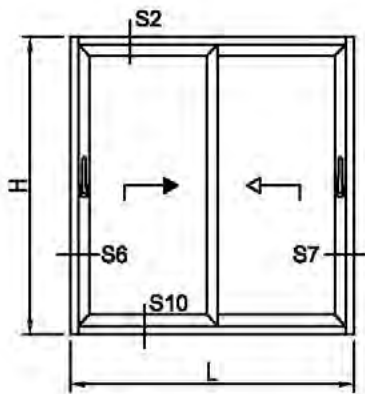

SECCIÓN 10

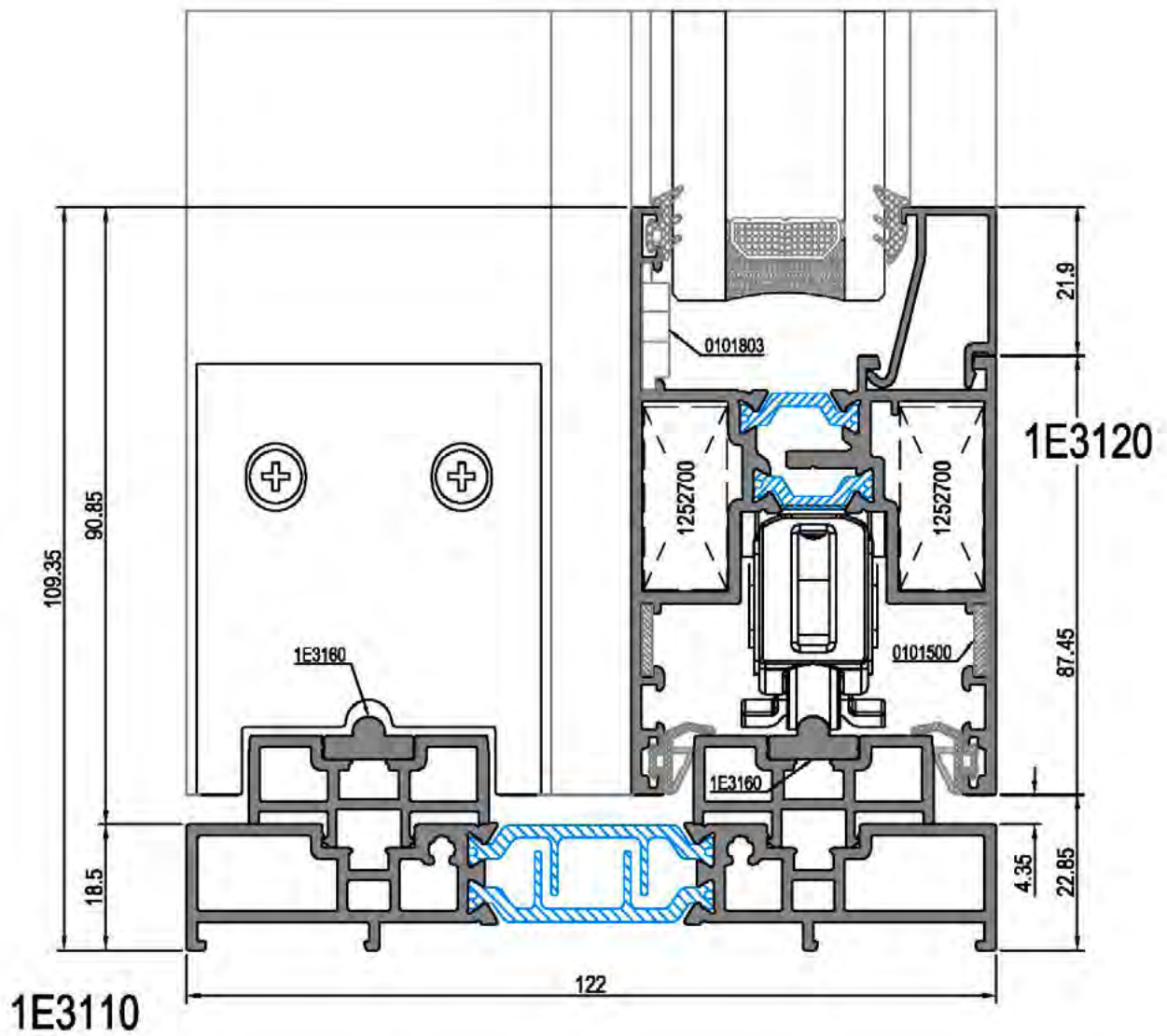

Escala 1:1

ELEGANCE

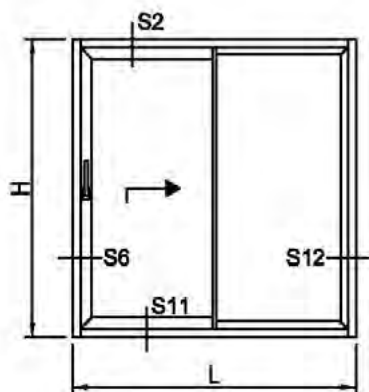

SECCIÓN 11

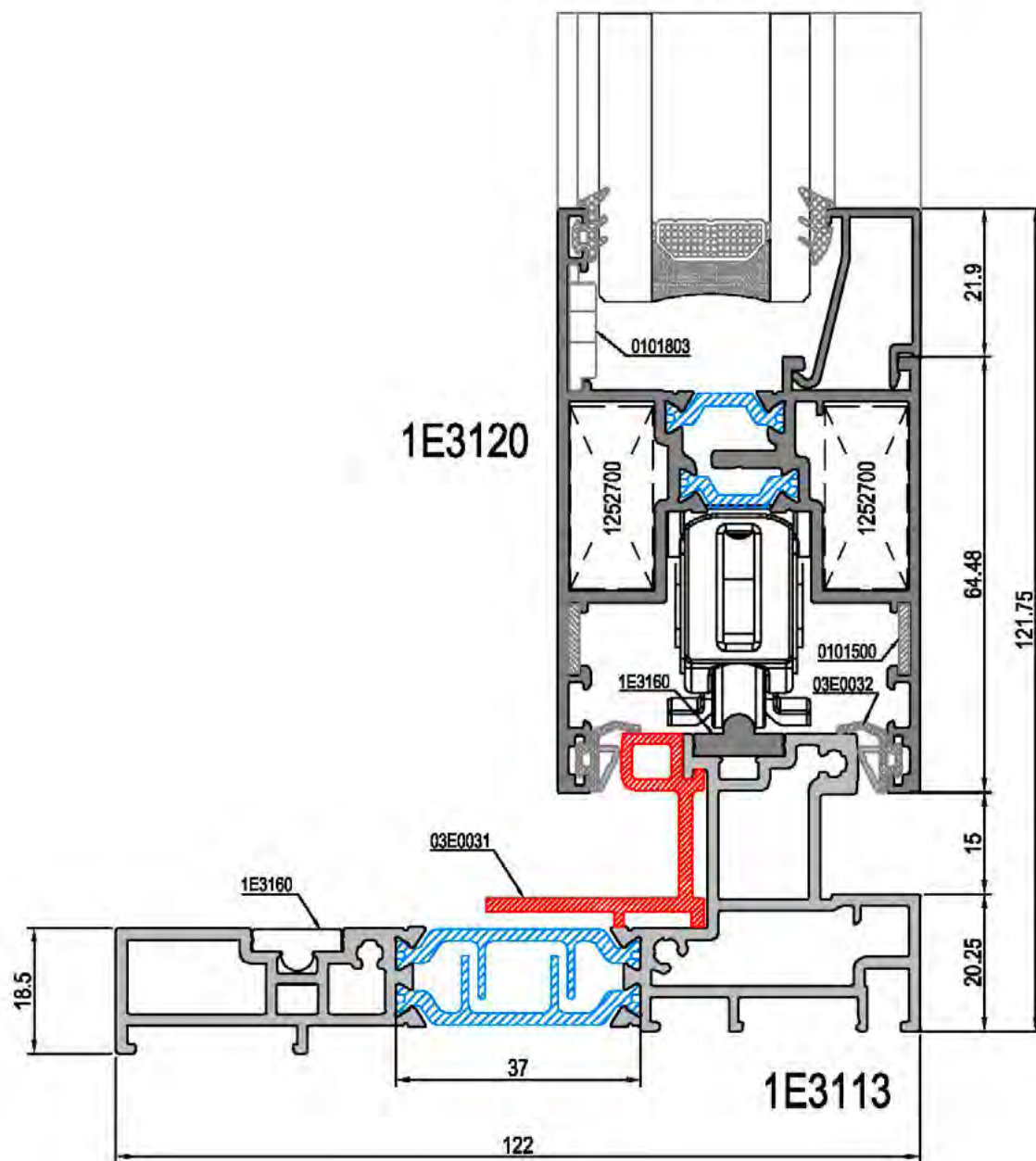

Escala 1:1

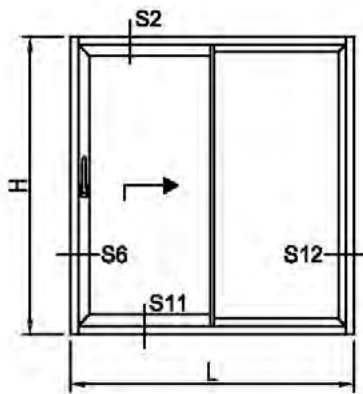

SECCIÓN 12

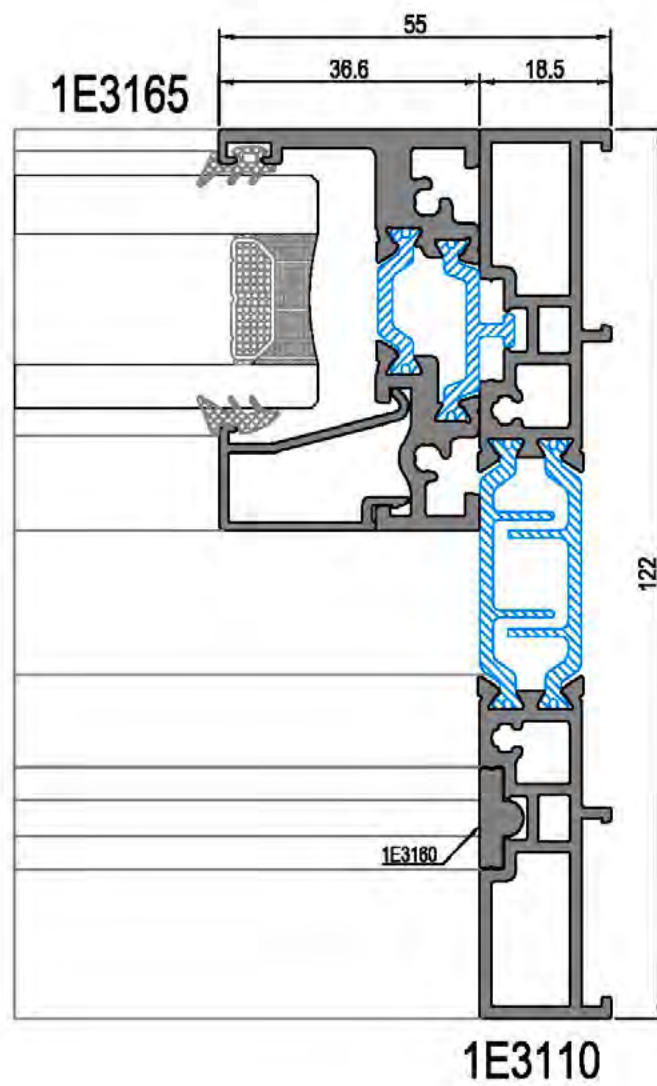

Escala 1:1

ELEGANCE

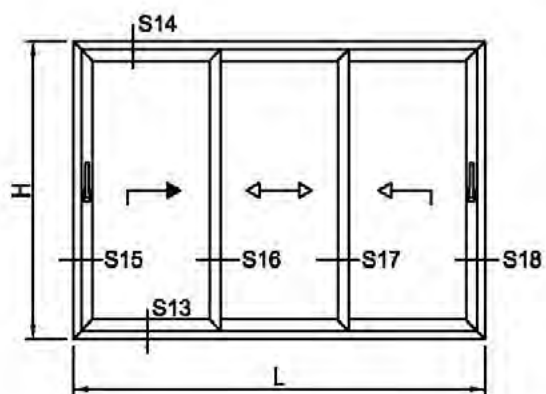

SECCIÓN 13

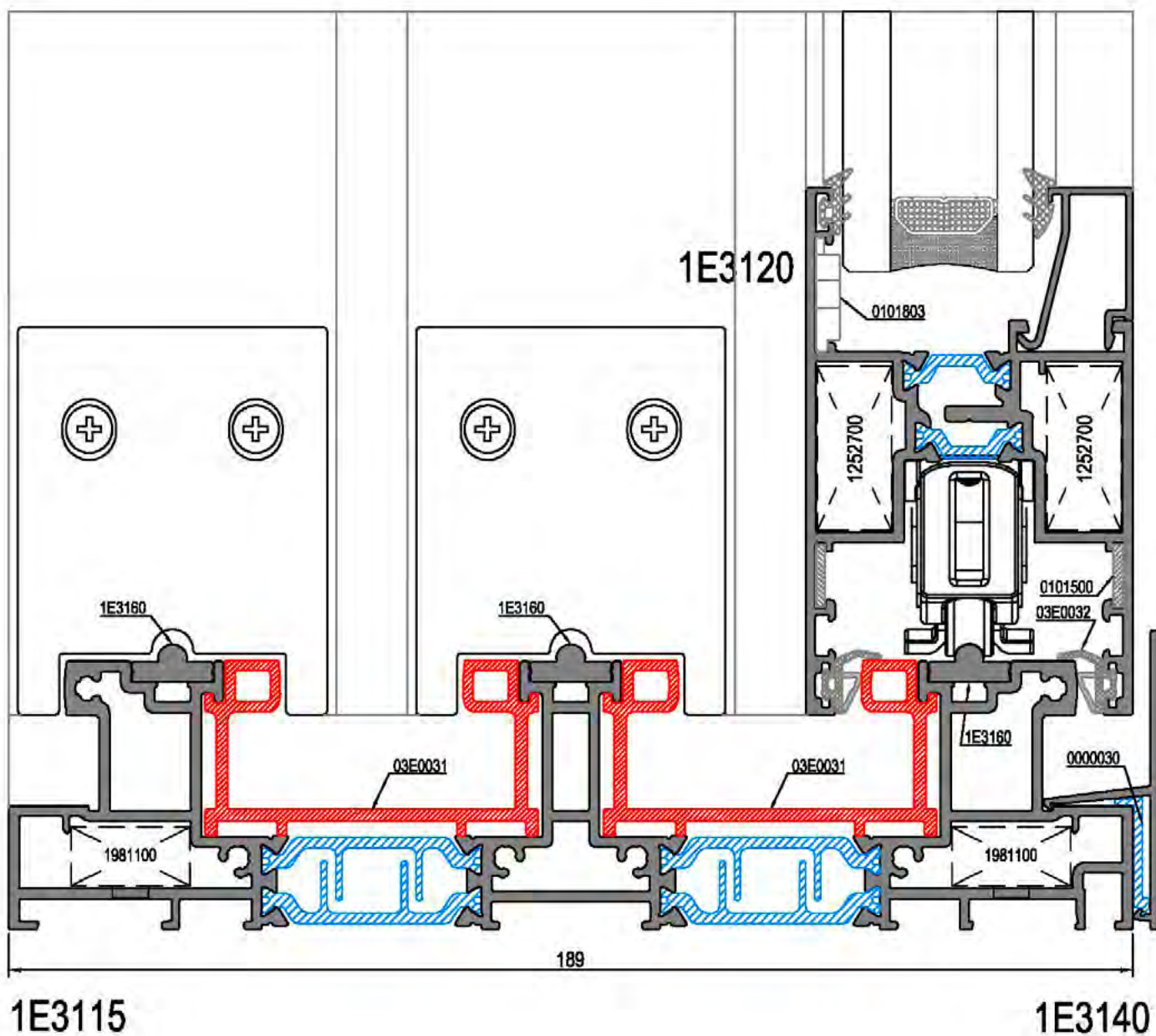

Escala 1:1

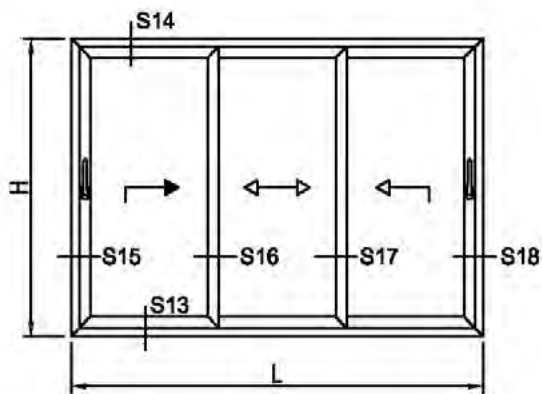

SECCIÓN 14

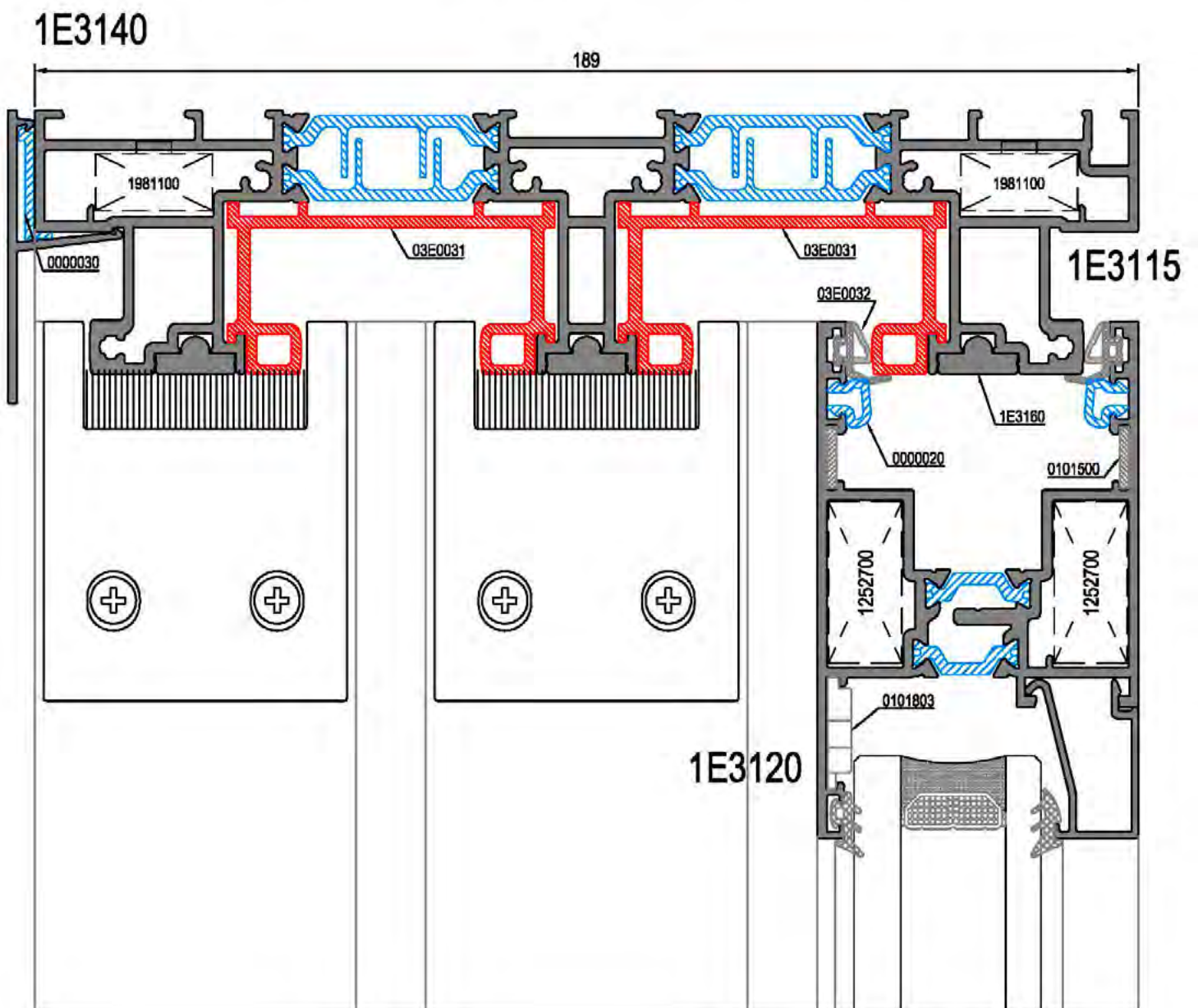

Escala 1:1

SECCIÓN 15

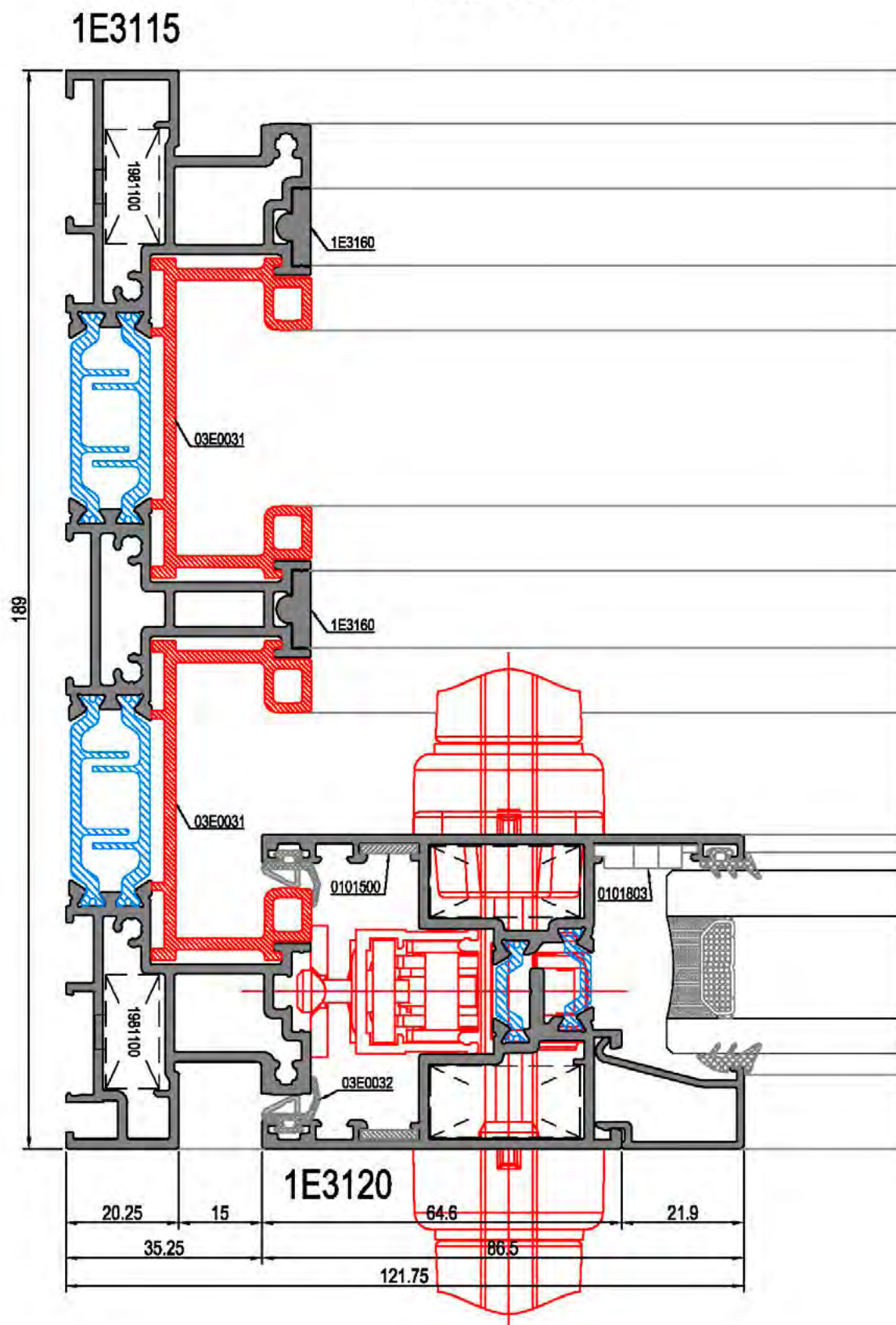

SECCIÓN 16

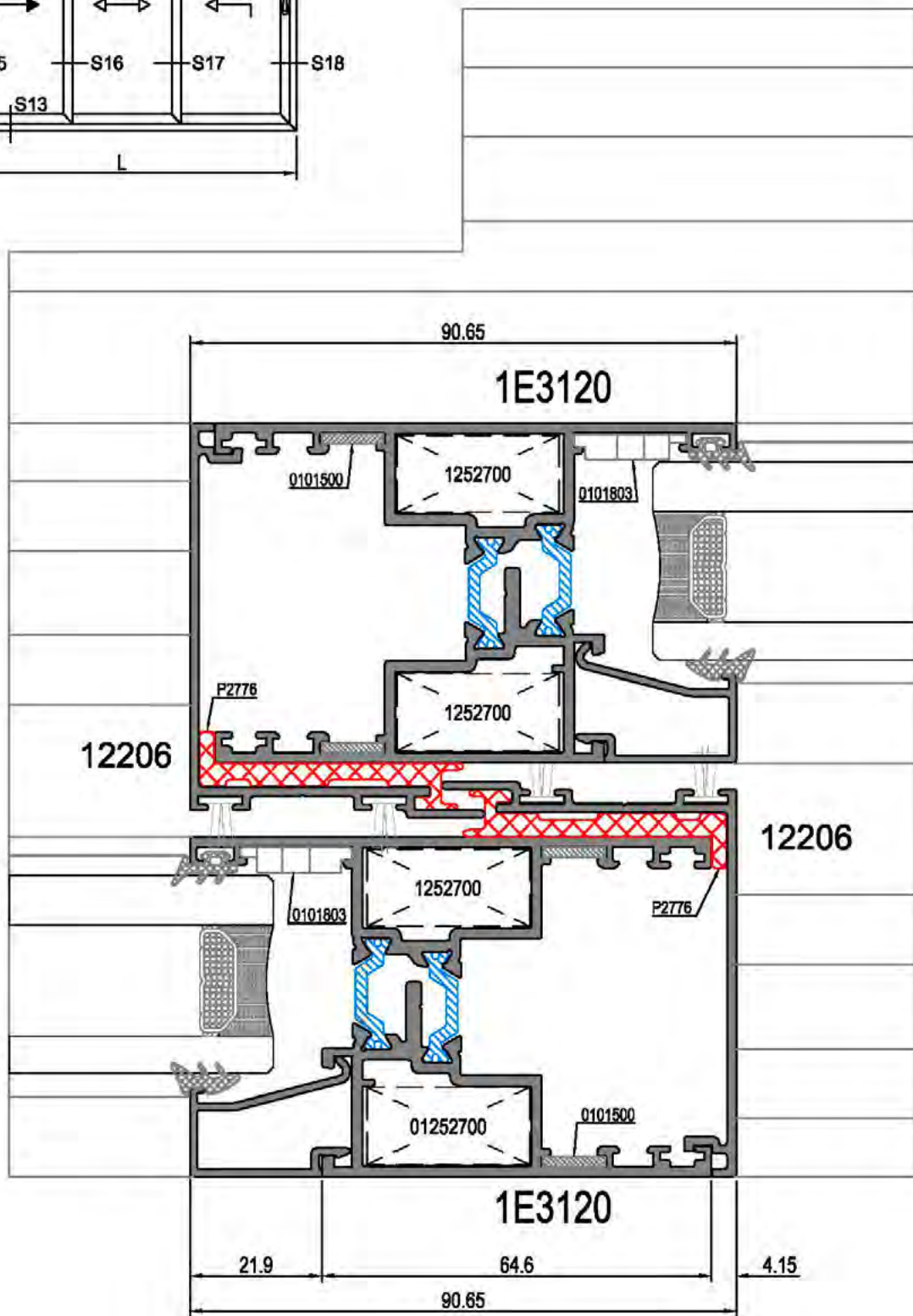
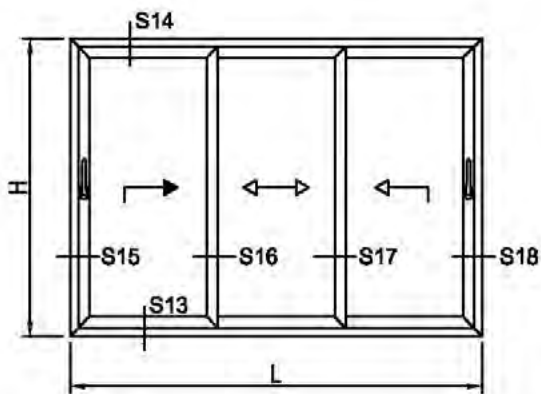

Escala 1:1

SECCIÓN 17

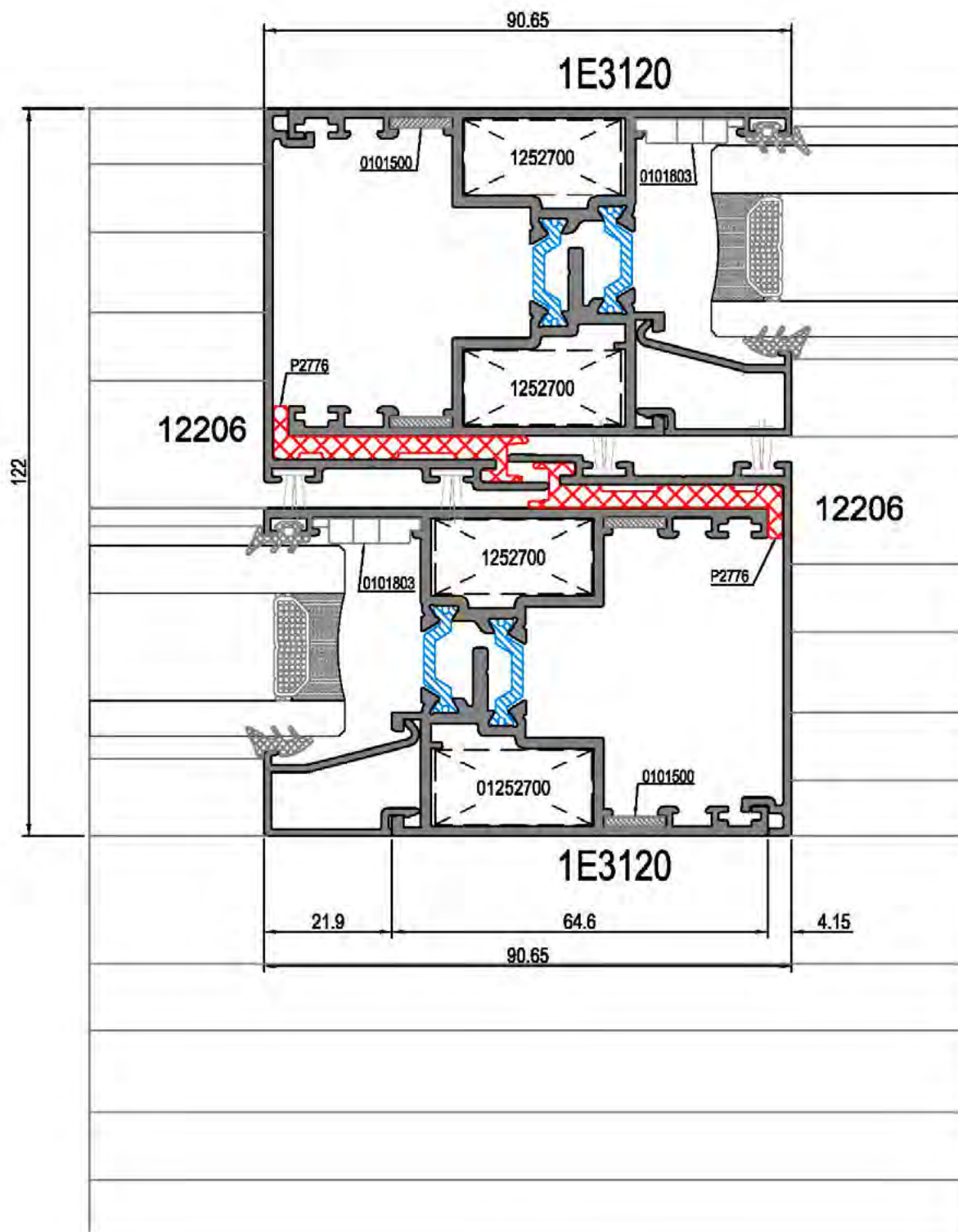

Escala 1:1

SECCIÓN 18

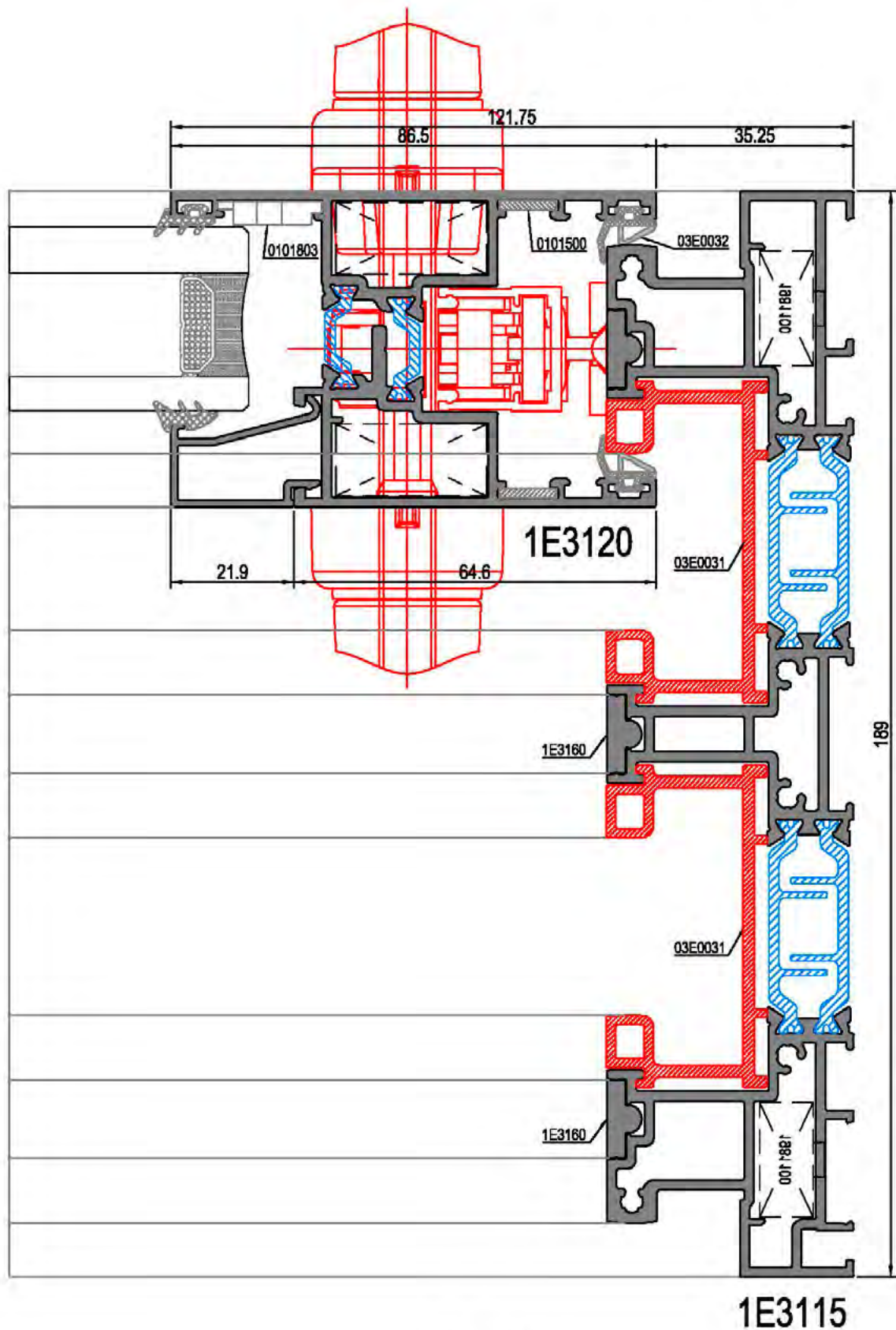

Escala 1:1

Puerta corredera 2 hojas / Marco perimetral

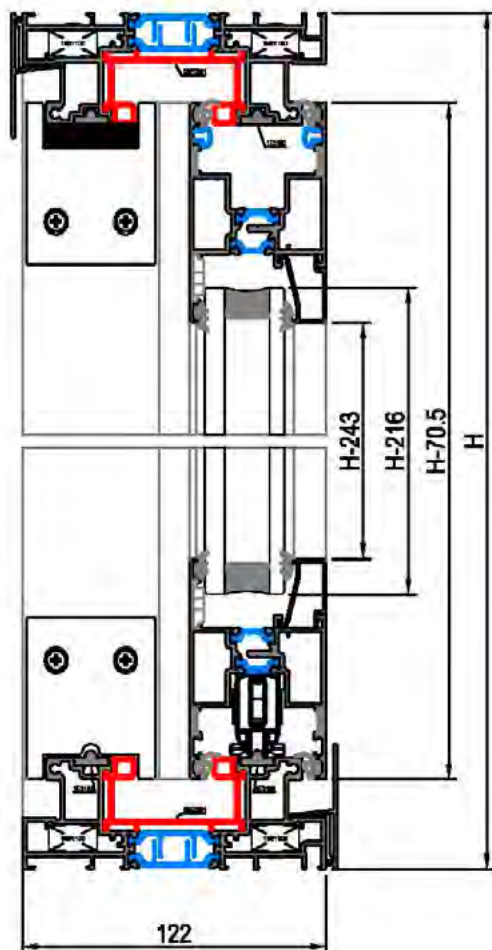
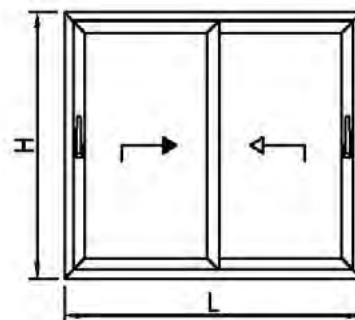

Den.	Und.	Referenc.	Descripción	Corte	Medidas
Marco	2	1E3100	Marco lateral		H
	2	1E3100	Marco superior / inferior		L
Hoja	4	1E3120	Hoja lateral		H - 70,5
	4	1E3120	Hoja superior / inferior		L/2 + 5,9
	2	12206	Perfil de cruce		H - 70,5
	4	1E3160	Carril rodadura sup/inf.		L - 81
	4	1E3160	Carril rodadura lateral		H - 81
	2	1E3140	Clip marco condensación		L
	4	40525	Junquillo lateral		H - 243
	4	40525	Junquillo superior / inferior		L/2 - 123,3
	2	03E0031	U marco		2L
	2	03E0031	U marco		2H
Acristalamiento			L/2-139 x H-216 (2 Uds)		

Den.	Undidades	Referenc.	Descripción
Accesorios	8	1981100	Escuadra marco
	16	1252700	Escuadra hoja
	16	0101500	Escuadra alineamiento 10 x1,5
	8	0101803	Escuadra alineamiento
	1	1770022	Kit elevable Elegance
	8	0000020	Grapa guía superior
	2	302264	Tapa salida de agua
	6 x metro	0000030	Clip fijación 1E3140
Juntas	4H	0106575	Felpa TRI-FIN 6.5x7.5 negro
	4L + 4H	03E0032	Junta hoja
	2L + 4H		Junta acristalar (según vidrio)
	2L + 4H		Junta acristalar (según vidrio)
	2 (H - 70.6)	P2776	Junta cruce

Escala Sección 1:3

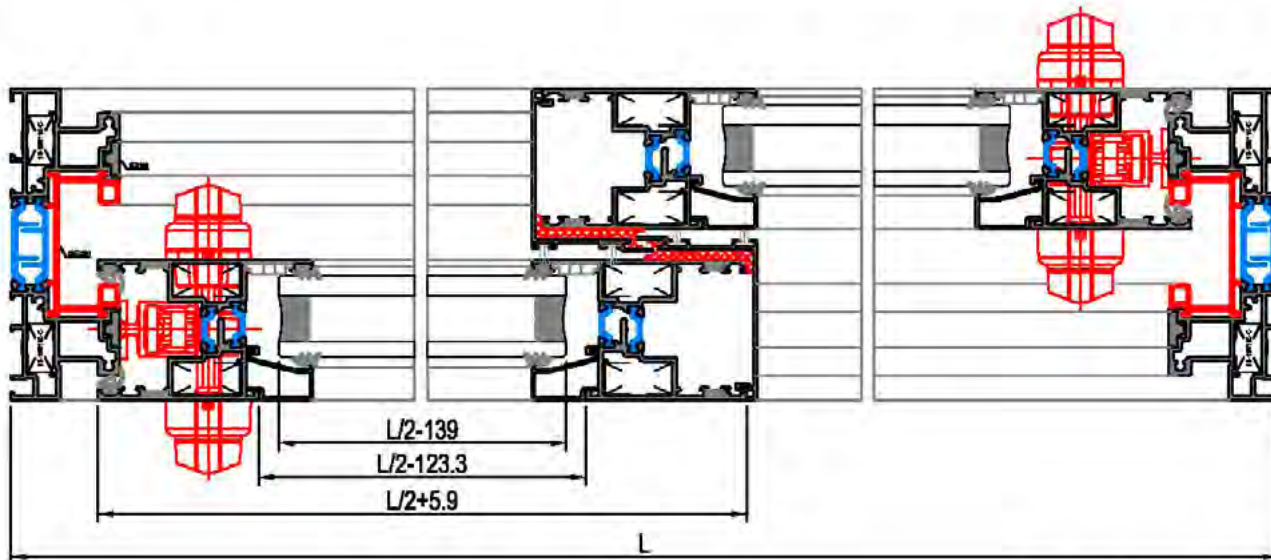

Puerta corredera 2 hojas / Marco corte recto

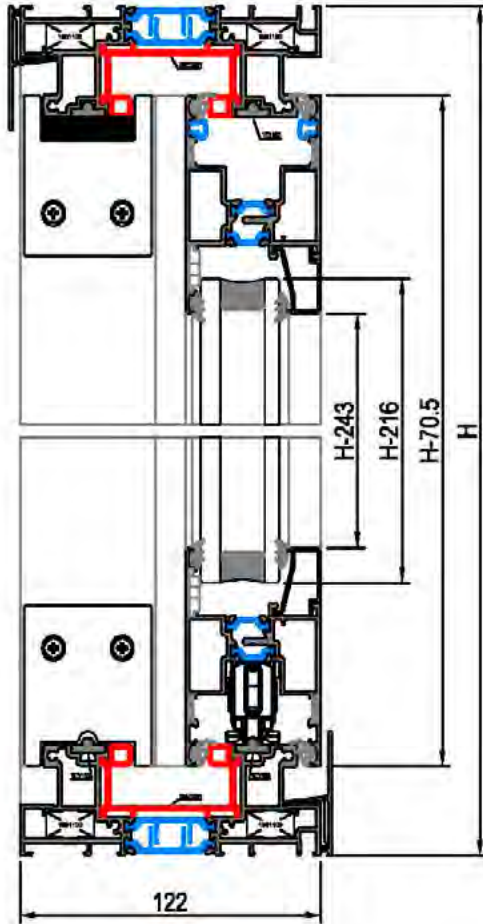
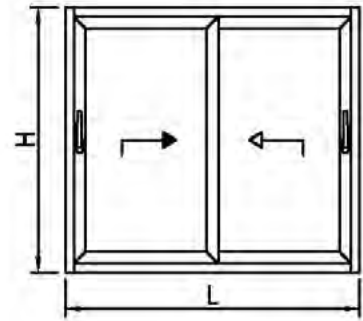

Den.	Und.	Referenc.	Descripción	Corte	Medidas
Marco	2	1E3110	Marco lateral		H
	2	1E3100	Marco superior / inferior		L - 37
	2	1E3150	Clip para marco		H - 88
Hoja	4	1E3120	Hoja lateral		H - 70.5
	4	1E3120	Hoja superior / inferior		L/2 + 18.3
	2	12206	Perfil de cruce		H - 70.6
	4	1E3180	Carril rodadura sup/inf.		L - 37
	4	1E3160	Carril rodadura lateral		H
	2	1E3140	Clip marco condensación		H - 88
	4	40525	Junquillo lateral		H - 243
	4	40525	Junquillo superior / inferior		L/2 - 110.9
	2	03E0031	U marco (2Uds)		L-40
Acristalamiento			L/2-125 x H-216		

Den.	Unidades	Referenc.	Descripción
Accesorios	16	1252700	Escuadra hoja
	16	0101500	Escuadra alineamiento 10 x1,5
	8	0101803	Escuadra alineamiento
	1	1770022	Kit elevable Elegance
	8	0000020	Grapa guía superior
	2	302284	Tapa salida de agua
	6 x metro	0000030	Clip fijación 1E3140
Juntas	4H	0106575	Felpa TRI-FIN 6.5x7.5 negro
	4L + 4H	03E0032	Junta hoja
	2L + 4H		Junta acristalar (según vidrio)
	2L + 4H		Junta acristalar (según vidrio)
	2(H - 70.6)	P2776	Junta cruce

Escala Sección 1:3

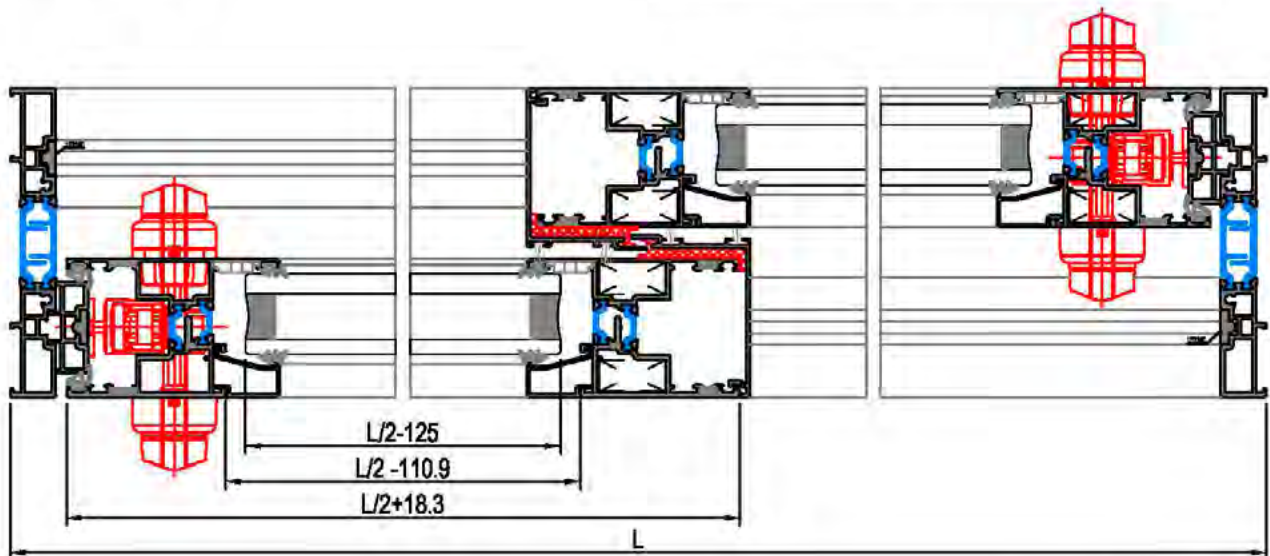

Puerta corredera 2 hojas / Marco minimalista

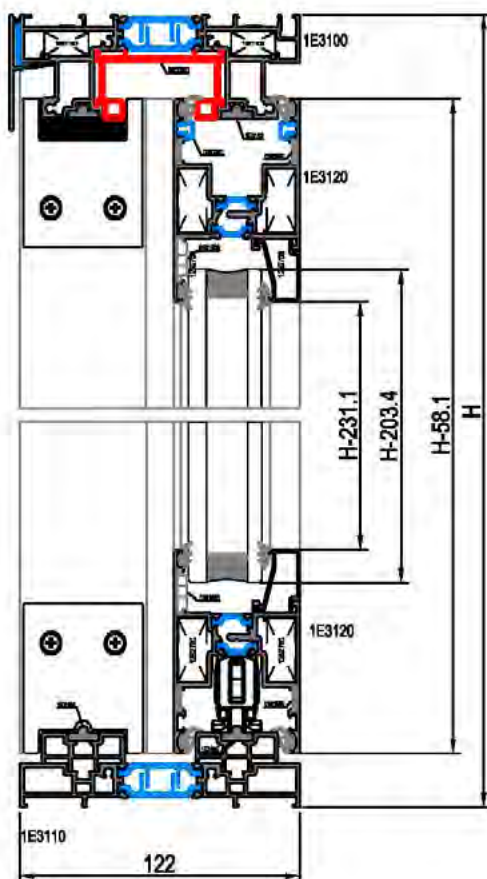
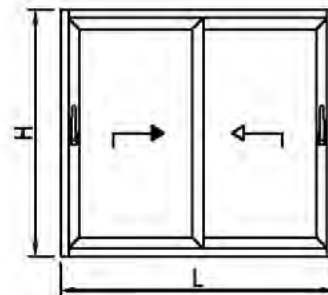

Escala Sección 1:3

Den.	Und.	Referenc.	Descripción	Corte	Medidas
Marco	2	1E3110	Marco lateral		H
	1	1E3110	Marco inferior		L - 37
	1	1E3100	Marco superior		L - 37
Hoja	2	1E3150	Clip para marco		H - 62.5
	4	1E3120	Hoja lateral		H - 58.1
	4	1E3120	Hoja superior / inferior		L/2 + 18.3
	2	12206	Perfil de cruce		H - 58.1
	4	1E3180	Carril rodadura sup/inf.		L - 37
	4	1E3160	Carril rodadura lateral		H
	2	1E3140	Clip marco condensación		H - 62.5
	2	1E3140	Clip marco condensación		L - 37
	4	40525	Junquillo lateral		H - 231.1
	4	40525	Junquillo superior / inferior		L/2 - 110.9
1	03E0031	U marco		L-40	
Acristalamiento			L/2-125 x H-203.4 (2Uds)		

Den.	Unidades	Referenc.	Descripción
Accesorios	16	1252700	Escuadra hoja
	16	0101500	Escuadra alineamiento 10 x1,5
	8	0101803	Escuadra alineamiento
	1	1770022	Kit elevable Elegance
	8	0000020	Grapa guía superior
	2	302264	Tapa salida de agua
	6 x metro	0000030	Clip fijación 1E3140
Juntas	4H	0106575	Felpa TRI-FIN 6.5x7.5 negro
	4L + 4H	03E0032	Junta hoja
	2L + 4H		Junta acristalar (según vidrio)
	2L + 4H		Junta acristalar (según vidrio)
	2(H - 70.6)	P2776	Junta cruce

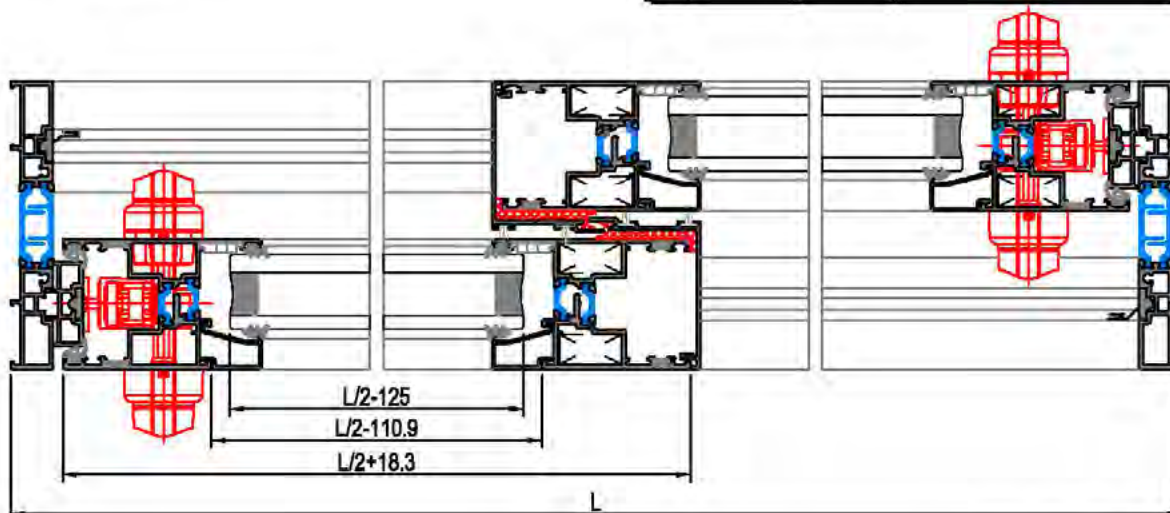

Escala Sección 1:3

Puerta corredera 2 hojas / Marco perimetral
Hojas a testa

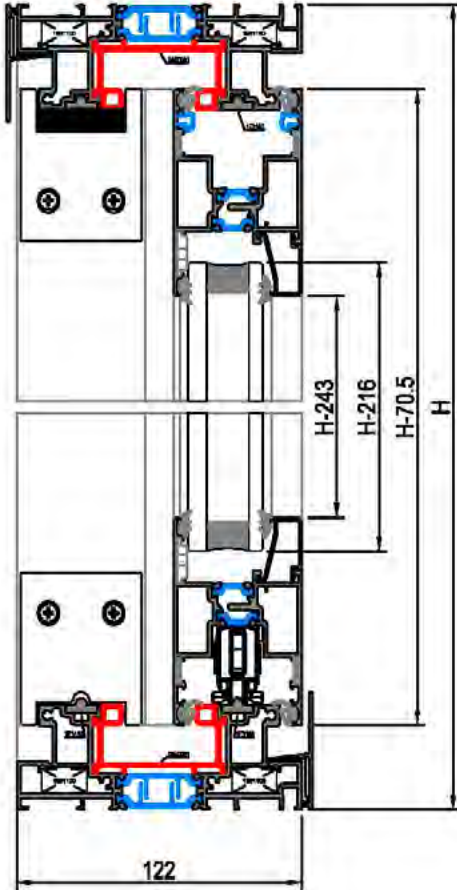
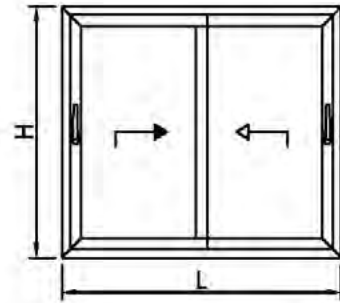

Escala Sección 1:3

Den.	Und.	Referenc.	Descripción	Corte	Medidas
Marco	2	1E3100	Marco lateral		H
	2	1E3100	Marco superior / inferior		L
Hoja	2	1E3120	Hoja lateral		H - 70.5
	4	1E3120	Hoja superior / inferior		L/2 - 20.2
	2	1E312	Hoja lateral		H - 188.7
	2	12206	Perfil de cruce		H - 70.5
	4	1E3160	Carril rodadura sup/inf.		L - 81
	4	1E3160	Carril rodadura lateral		H - 81
	2	1E3140	Clip marco condensación		L
	4	40525	Junquillo lateral		H - 243
	4	40525	Junquillo superior / inferior		L/2 - 99.4
	2	03E0031	U marco		L
2	03E0031	U marco		H	
Acristalamiento					L/2-115.6 x H-216 (2 Uds)

Den.	Undidades	Referenc.	Descripción
Accesorios	8	1981100	Escuadra marco
	8	1252700	Escuadra hoja
	8	0101500	Escuadra alineamiento 10 x1,5
	4	0101803	Escuadra alineamiento
	1	1770022	Kit elevable Elegance
	8	0000020	Grapa gula superior
	2	302264	Tapa salida de agua
	6 x metro	0000030	Clip fijación 1E3140
Juntas	2H	0106575	Felpa TRI-FIN 6.5x7.5 negro
	4L + 4H	03E0032	Junta hoja
	2L + 4H		Junta acristalar (según vidrio)
	2L + 4H		Junta acristalar (según vidrio)
	2 (H - 70.5)	1882308	Junta cruce

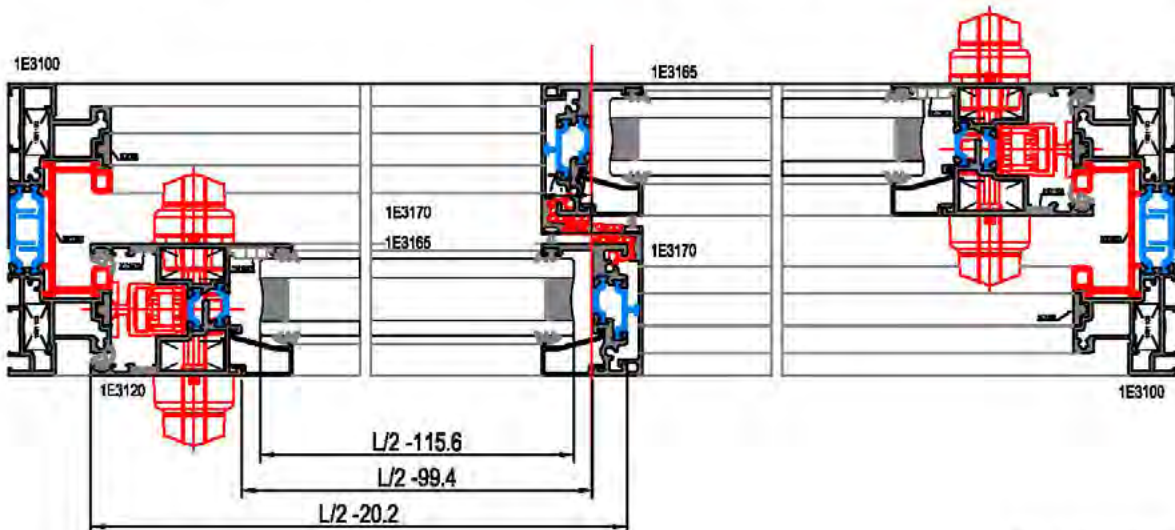

Escala Sección 1:3

ELEGANCE

Puerta corredera 2 hojas / Marco corte recto Hojas a testa

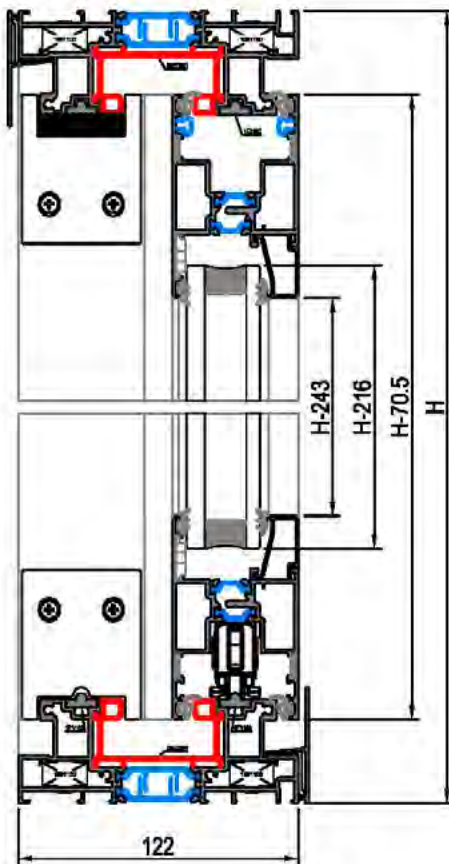
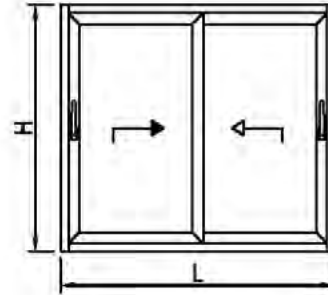

Escala Sección 1:3

Den.	Und.	Referenc.	Descripción	Corte	Medidas
Marco	2	1E3110	Marco lateral		H
	2	1E3100	Marco superior / inferior		L - 37
	2	1E3150	Clip para marco		H - 88
Hoja	2	1E3120	Hoja lateral		H - 70.5
	2	1E3185	Hoja lateral		H - 187.2
	4	1E3120	Hoja superior / inferior		L/2 - 7.5
	2	12206	Perfil de cruce		H - 70.5
	4	1E3160	Carril rodadura sup/inf.		L - 37
	4	1E3160	Carril rodadura lateral		H
	2	1E3140	Clip marco condensación		H - 88
4	40525	Junquillo lateral		H - 243	
4	40525	Junquillo superior / inferior		L/2 - 87	
2	03E0031	U marco		L - 40	
Acristalamiento			L/2-103.2 x H-216		

Den	Unidades	Referenc.	Descripción
Accesorios	8	1252700	Escuadra hoja
	8	0101500	Escuadra alineamiento 10 x1,5
	4	0101803	Escuadra alineamiento
	1	1770022	Kit elevable Elegance
	8	0000020	Grapa guía superior
	2	302264	Tapa salida de agua
Juntas	6 x metro	0000030	Clip fijación 1E3140
	4H	0106575	Felpa TRI-FIN 6,5x7,5 negro
	4L + 4H	03E0032	Junta hoja
	2L + 4H		Junta acristalar (según vidrio)
	2L + 4H		Junta acristalar (según vidrio)
	2(H - 70.6)	1882308	Junta cruce

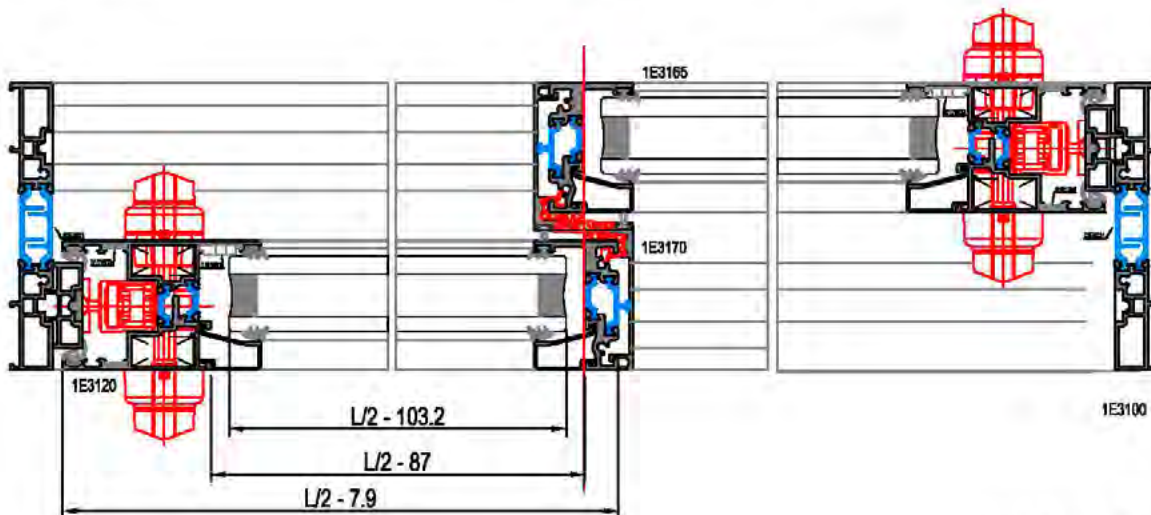

Escala Sección 1:3

Puerta corredera 2 hojas / Marco minimalista
Hojas a testa

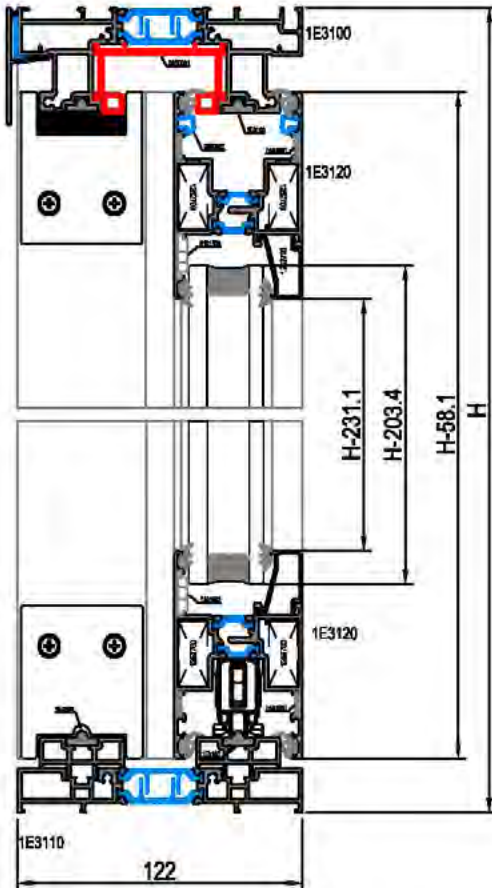
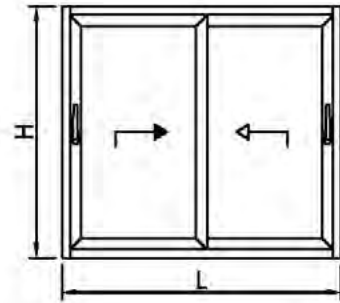

Escala Sección 1:3

Den.	Und.	Referenc.	Descripción	Corte	Medidas
Marco	2	1E3110	Marco lateral		H
	1	1E3110	Marco superior / inferior		L - 37
	1	1E3100	Marco superior / inferior		L - 37
Hoja	2	1E3150	Clip para marco		H - 88
	2	1E3120	Hoja lateral		H - 58.1
	2	1E3165	Hoja lateral		H - 187.2
	4	1E3120	Hoja superior / inferior		L/2 - 7.5
	2	12206	Perfil de cruce		H - 70.5
	4	1E3180	Carril rodadura sup/inf.		L - 37
	4	1E3180	Carril rodadura lateral		H
	2	1E3140	Clip marco condensación		H - 88
Accesorios	4	40525	Junquillo lateral		H - 231.1
	4	40525	Junquillo superior / inferior		L/2 - 87
	1	03E0031	U marco		L - 40
	Acristalamiento		L/2-103.2 x H-203.4		

Den	Unidades	Referenc.	Descripción
Accesorios	8	1252700	Escuadra hoja
	8	0101500	Escuadra alineamiento 10 x1,5
	4	0101803	Escuadra alineamiento
	1	1770022	Kit elevable Elegance
	8	0000020	Grapa guía superior
	2	302264	Tapa salida de agua
Juntas	6 x metro	0000030	Clip fijación 1E3140
	4H	0106575	Felpa TRI-FIN 6.5x7.5 negro
	4L + 4H	03E0032	Junta hoja
	2L + 4H		Junta acristalar (según vidrio)
	2L + 4H		Junta acristalar (según vidrio)
	2(H - 70.6)	1882308	Junta cruce

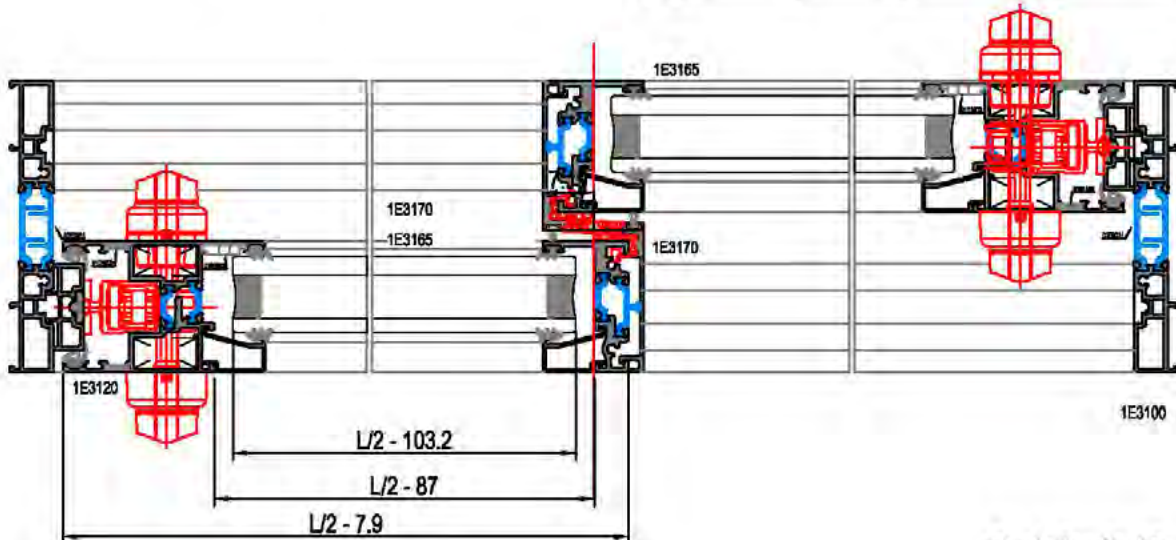

Escala Sección 1:3

Puerta corredera 3 hojas / Marco perimetral

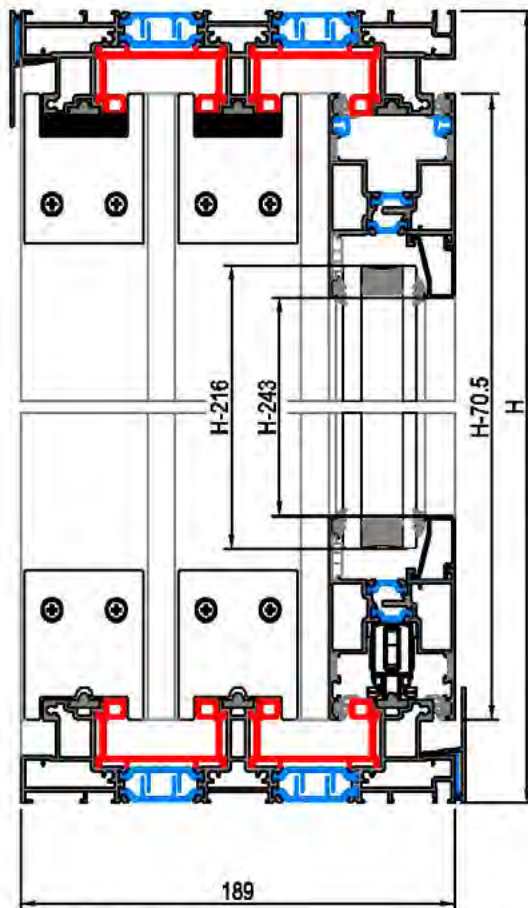
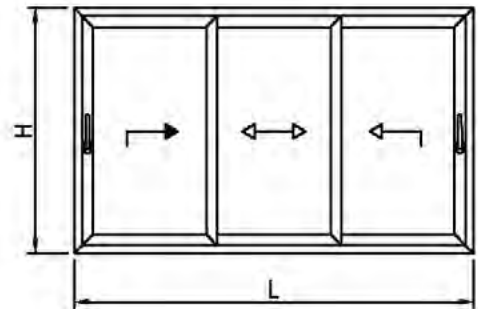

Escala Sección 1:3

Den.	Und.	Referenc.	Descripción	Corte	Medidas
Marco	2	1E3115	Marco lateral		H
	2	1E3115	Marco superior / inferior		L
Hoja	6	1E3120	Hoja lateral		H - 70.5
	6	1E3120	Hoja superior / inferior		L/3 + 31
	4	12206	Perfil de cruce		H - 70.5
	6	1E3160	Carril rodadura sup/inf.		L - 81
6	1E3160	Carril rodadura lateral		H - 81	
2	1E3140	Clip marco condensación		L	
6	40525	Junquillo lateral		H - 243	
6	40525	Junquillo superior / inferior		L/3 - 98.2	
4	03E0031	U marco		2H + 2L	
Acristalamiento			L/3-114 x H-216 - (3 uds)		

Den.	Unidades	Referenc.	Descripción
Accesorios	8	1981100	Escuadra marco
	24	1252700	Escuadra hoja
	24	0101500	Escuadra alineamiento 10 x1,5
	12	0101803	Escuadra alineamiento
	2	1770022	Kit elevable Elegance
	12	0000020	Grapa guía superior
	2 - 4	302264	Tapa salida de agua
Juntas	6 x metro	0000030	Clip fijación 1E3140
	8H	0106575	Felpa TRI-FIN 6,5x7,5 negro
	6L + 6H	03E0032	Junta hoja
	2L + 6H		Junta acristalar (según vidrio)
	2L + 6H		Junta acristalar (según vidrio)
4 (H - 70.6)	P2776	Junta cruce	

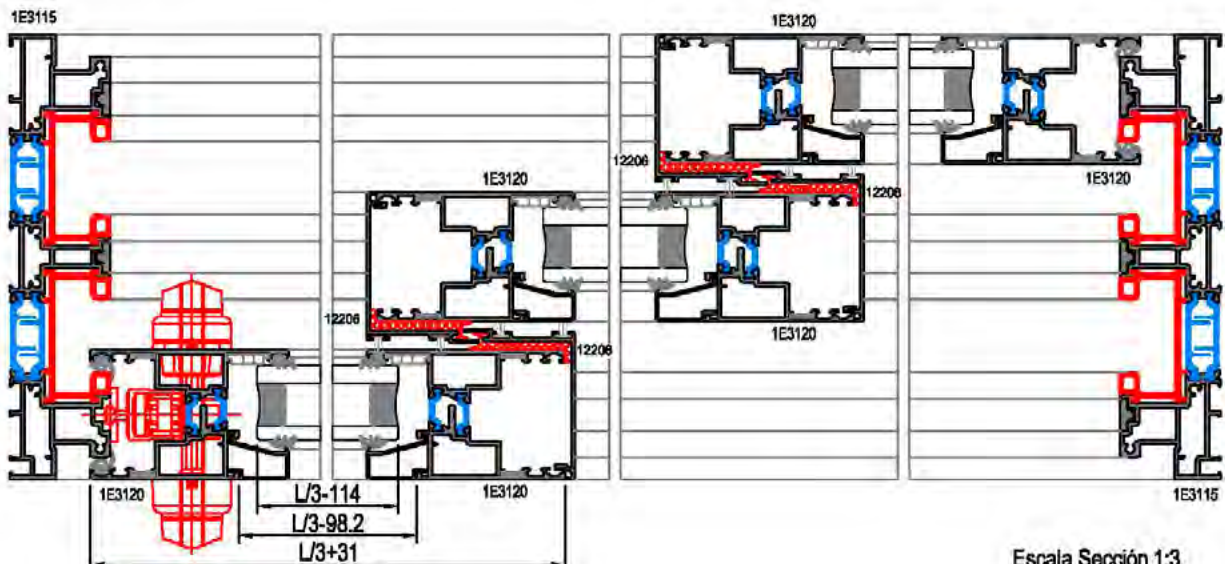

Escala Sección 1:3

Puerta corredera 3 hojas / Marco corte recto

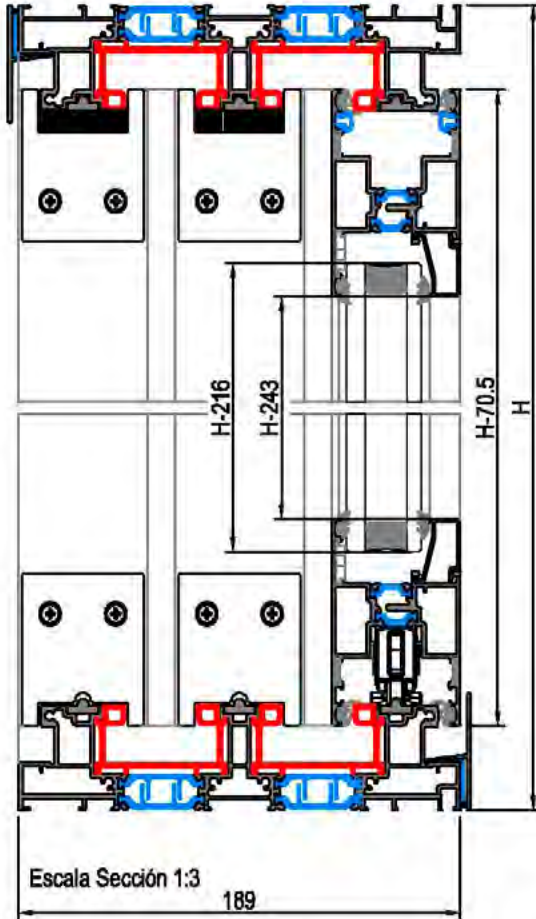
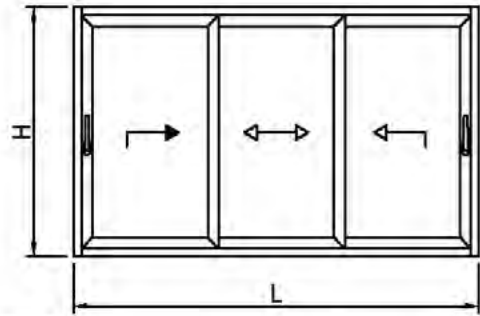

Den.	Und.	Referenc.	Descripción	Corte	Medidas
Marco	2	1E3125	Marco lateral		H
	2	1E3115	Marco superior / inferior		L - 37
Hoja	6	1E3120	Hoja lateral		H - 70.5
	6	1E3120	Hoja superior / inferior		L/3 + 40
	4	12208	Perfil de cruce		H - 70.5
	6	1E3160	Carril rodadura sup/inf.		L - 81
	6	1E3160	Carril rodadura lateral		H - 81
	2	1E3140	Clip marco condensación		L
	6	40525	Junquillo lateral		H - 243
	6	40525	Junquillo superior / inferior		L/3 - 89.5
4	03E0031	U marco		L - 37	
Acristalamiento			L/3-105.7 x H-216 - 3 uds		

Den.	Unidades	Referenc.	Descripción
Accesorios	24	1252700	Escuadra hoja
	24	0101500	Escuadra alineamiento 10 x1,5
	12	0101803	Escuadra alineamiento
	2	1770022	Kit elevable Elegance
	12	0000020	Grapa guía superior
	2 - 4	302264	Tapa salida de agua
	6 x metro	0000030	Clip fijación 1E3140
Juntas	8H	0106575	Felpa TRI-FIN 6.5x7.5 negro
	6L + 6H	03E0032	Junta hoja
	2L + 6H		Junta acristalar (según vidrio)
	2L + 6H		Junta acristalar (según vidrio)
	4 (H - 70.6)	P2776	Junta cruce

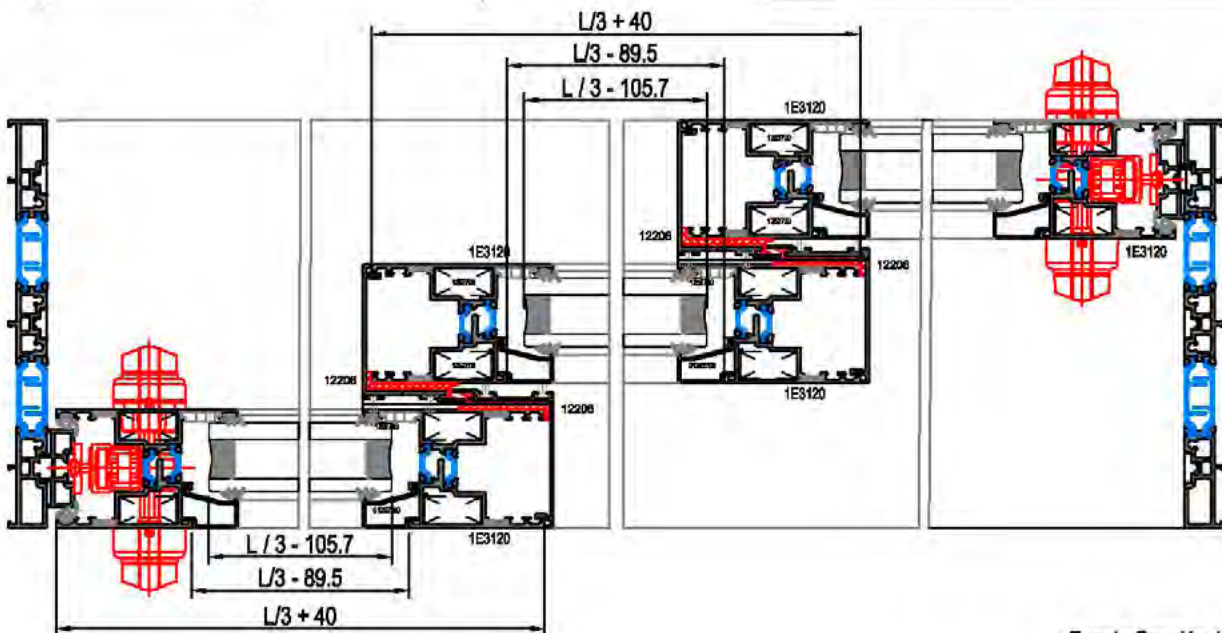

ELEGANCE

Puerta corredera 3 hojas / Marco minimalista

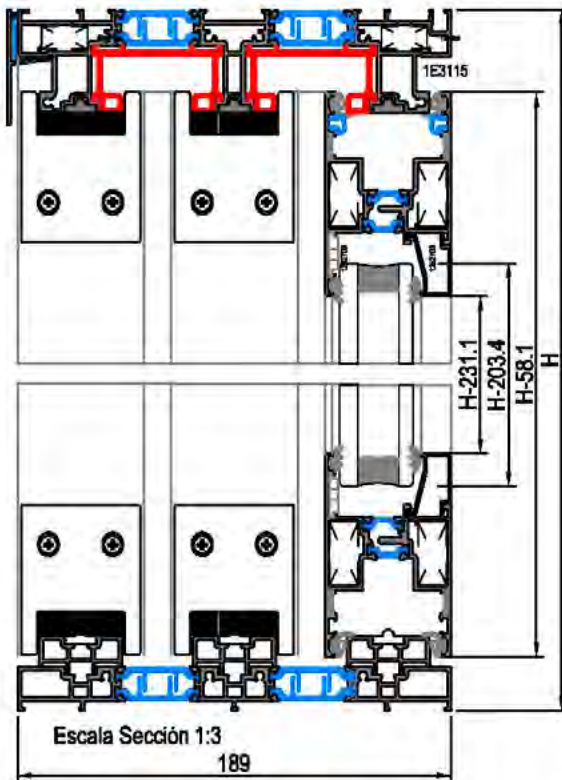
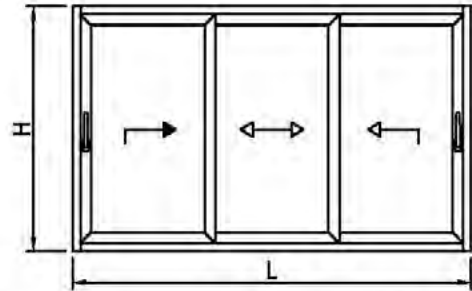

	Referenc.	Descripción	Corte	Medidas
Marco	2	1E3125	Marco lateral	H
	1	1E3115	Marco superior	L - 37
	1	1E3125	Marco inferior	L - 37
Hoja	6	1E3120	Hoja lateral	H - 58,1
	6	1E3120	Hoja superior / inferior	L / 3 + 40
	4	12206	Perfil de cruce	H - 58,1
	6	1E3160	Camil rodadura sup/inf.	L - 81
	6	1E3160	Camil rodadura lateral	H - 81
	2	1E3140	Clip marco condensación	L
	6	40525	Junquillo lateral	H - 231,1
	6	40525	Junquillo superior / inferior	L / 3 - 89,5
2	03E0031	U marco	L - 37	
Acristalamiento		L / 3 - 105,7 x H - 203,4 - 3uds		

Den	Undidades	Referenc.	Descripción
Accesorios	24	1252700	Escuadra hoja
	24	0101500	Escuadra alineamiento 10 x1,5
	12	0101803	Escuadra alineamiento
	2	1770022	Kit elevable Elegance
	12	0000020	Grapa guía superior
	2 - 4	302264	Tapa salida de agua
Juntas	6 x metro	0000030	Clip fijación 1E3140
	8H	0106575	Felpa TRI-FIN 6.5x7.5 negro
	6L + 6H	03E0032	Junta hoja
	2L + 6H		Junta acristalar (según vidrio)
	2L + 6H		Junta acristalar (según vidrio)
	4 (H - 70.6)	P2776	Junta cruce

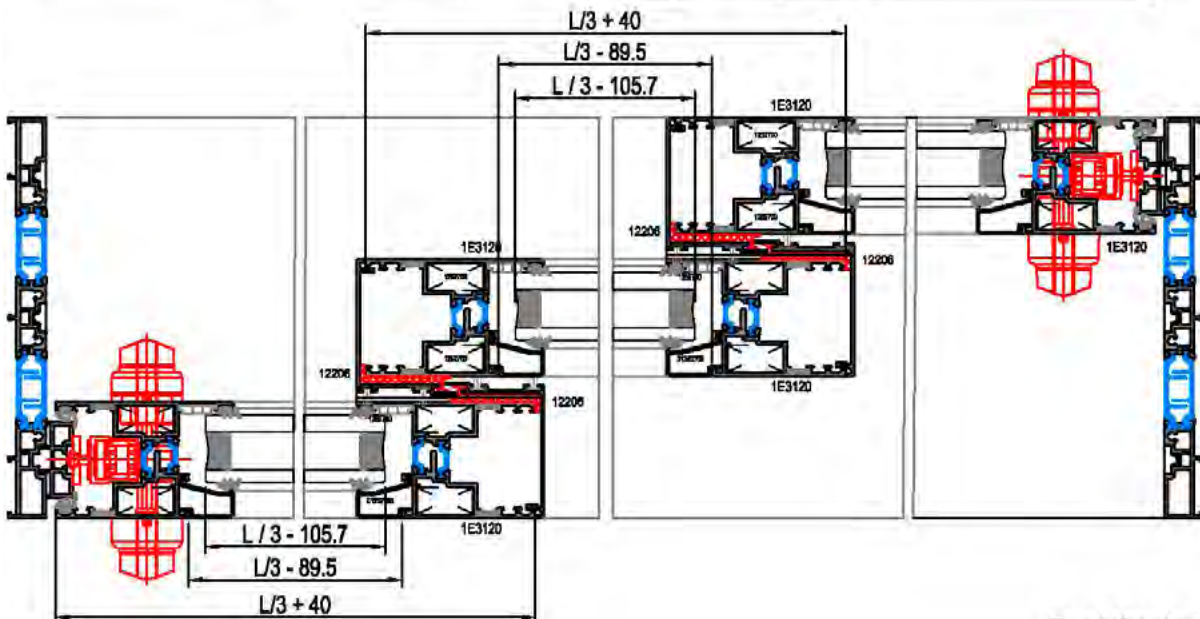

Escala Sección 1:3

Puerta corredera 4 hojas
Marco perimetral

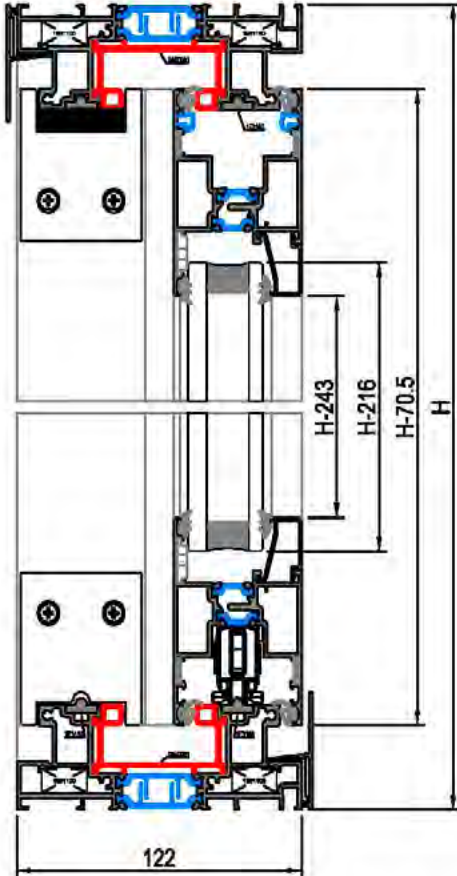
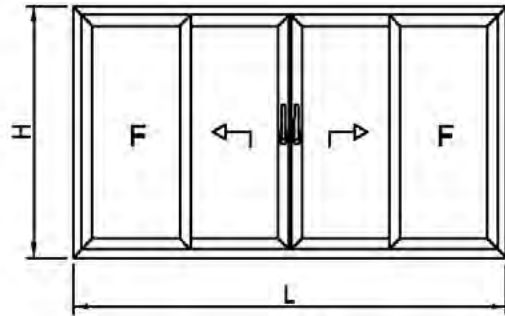

Escala Sección 1:3

Den.	Und.	Referenc.	Descripción	Corte	Medidas
Marco	2	1E3100	Marco lateral		H
	2	1E3100	Marco superior / inferior		L
Hoja	8	1E3120	Hoja lateral		H - 70,5
	8	1E3120	Hoja superior / inferior		L/4 + 22,5
	4	12206	Perfil de cruce		H - 70,5
	1	1E3135	Unión de 4 hojas		H - 150
	4	1E3160	Carril rodadura sup/inf.		L - 81
	4	1E3160	Carril rodadura lateral		H - 81
	2	1E3140	Clip marco condensación		L
	8	40525	Junquillo lateral		H - 243
	8	40525	Junquillo superior / inferior		L/4-106.8
	2	03E0031	U marco		H
	2	03E0031	U marco		L
Acristalamiento					L/4-122 x H-216

Den.	Undidades	Referenc.	Descripción
Accesorios	8	1981100	Escuadra marco
	32	1252700	Escuadra hoja
	32	0101500	Escuadra alineamiento 10 x1,5
	16	0101803	Escuadra alineamiento
	3	1770022	Kit elevable Elegance
	16	0000020	Grapa gula superior
	4	302264	Tapa salida de agua
	6 x metro	0000030	Clip fijación 1E3140
	2	0000060	Tapa 4 hojas 1E3135
	8	0000050	Caizo hoja fija
Juntas	8H	0106575	Felpa TRI-FIN 6.5x7.5 negro
	4L + 6H	03E0032	Junta hoja
	2L + 8H		Junta acristalar (según vidrio)
	2L + 8H		Junta acristalar (según vidrio)
	4 (H - 70,6)	P2776	Junta cruce

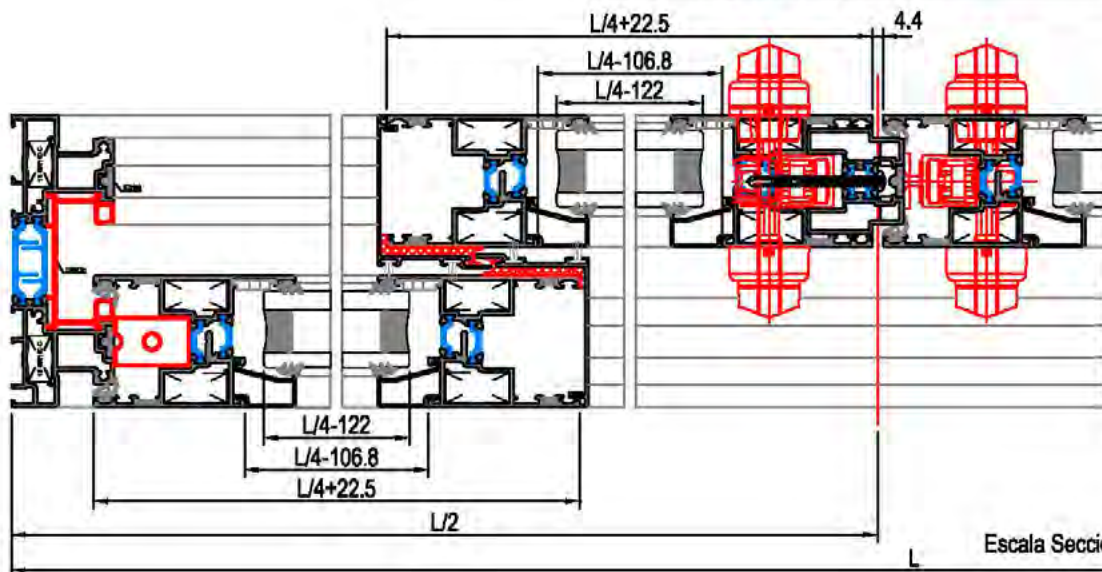

Escala Sección 1:3

ELEGANCE

Puerta corredera 4 hojas Marco corte recto

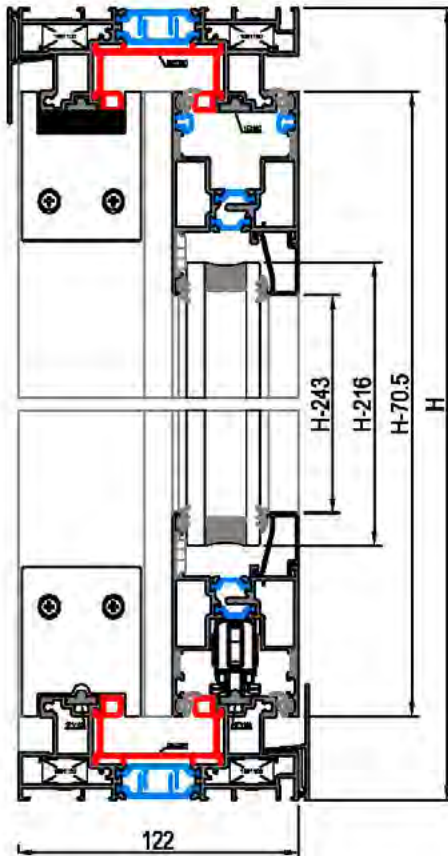
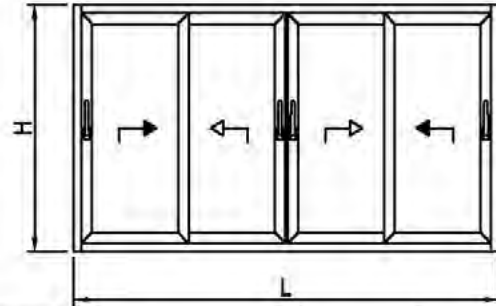

Escala Sección 1:3

Den.	Und.	Referenc.	Descripción	Corte	Medidas
Marco	2	1E3110	Marco lateral		H
	2	1E3100	Marco superior / inferior		L - 37
	2	1E3150	Clip para marco		H - 88
Hoja	8	1E3120	Hoja lateral		H - 70.5
	8	1E3120	Hoja superior / inferior		L/4 + 28.7
	4	12206	Perfil de cruce		H - 70.5
	1	1E3135	Unión de 4 hojas		H - 160
	4	1E3160	Carril rodadura sup/inf.		L - 37
	4	1E3160	Carril rodadura lateral		H
	2	1E3140	Clip marco condensación		L
	8	40525	Junquillo lateral		H - 243
	8	40525	Junquillo superior / inferior		L/4 - 100.6
	2	03E0031	U marco		L - 37
Acristalamiento			L/4 - 116 x H - 216		

Den	Unidades	Referenc.	Descripción
Accesorios	32	1252700	Escuadra hoja
	32	0101500	Escuadra alineamiento 10 x 1,5
	16	0101803	Escuadra alineamiento
	3	1770022	Kit elevable Elegance
	16	0000020	Grapa guía superior
	4	302264	Tapa salida de agua
	6 x metro	0000030	Clip fijación 1E3140
Juntas	2	0000080	Tapa 4 hojas 1E3135
	8H	0106575	Felpa TRI-FIN 6.5x7.5 negro
	4L + 6H	03E0032	Junta hoja
	2L + 8H		Junta acristalar (según vidrio)
	2L + 8H		Junta acristalar (según vidrio)
4(H - 70.6)	P2776	Junta cruce	

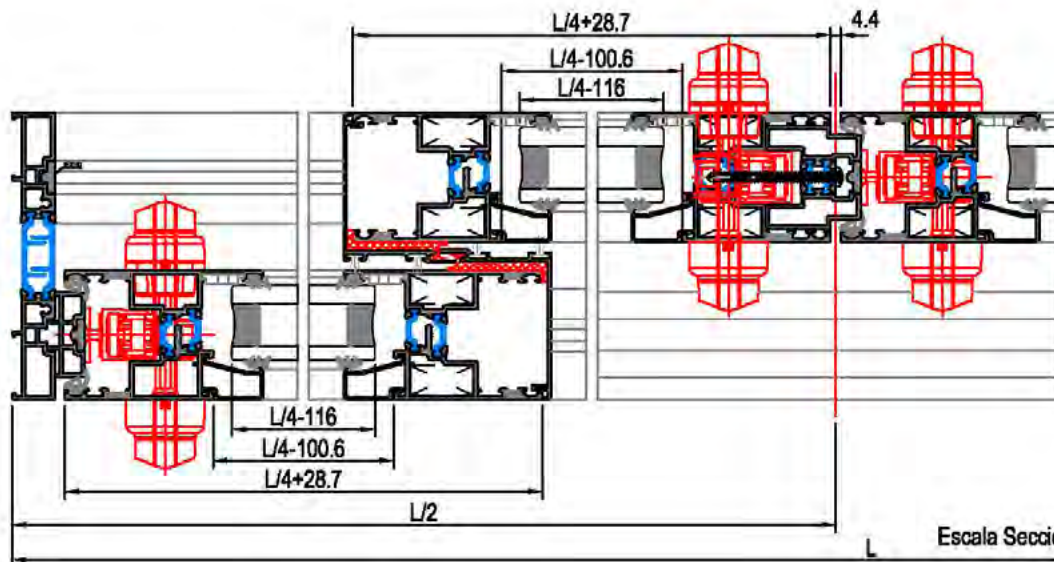

Escala Sección 1:3

Puerta corredera 4 hojas
Marco a testa minimalista

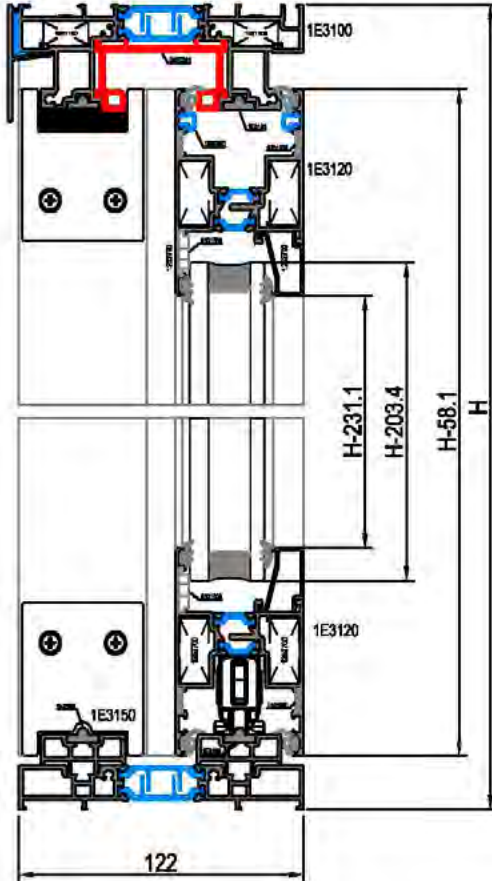
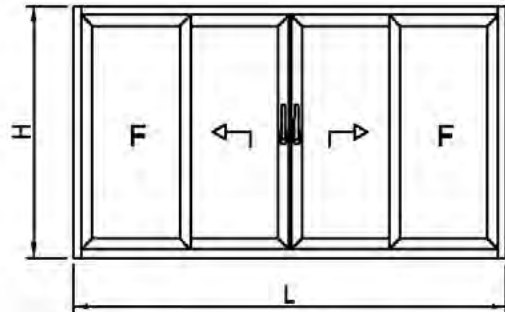

Escala Sección 1:3

Den.	Und.	Referenc.	Descripción	Corte	Medidas
Marco	2	1E3110	Marco lateral		H
	1	1E3110	Marco superior / inferior		L - 37
	1	1E3100	Marco superior / inferior		L - 37
Hoja	2	1E3150	Clip para marco		H - 75
	2	1E3150	Clip para marco		L - 70
	8	1E3120	Hoja lateral		H - 58.1
	8	1E3120	Hoja superior / inferior		L/4 + 28.7
	4	12206	Perfil de cruce		H - 58.1
	1	1E3135	Unión de 4 hojas		H - 138
	4	1E3160	Carril rodadura sup/inf.		L - 37
	4	1E3160	Carril rodadura lateral		H
	2	1E3140	Clip marco condensación		L
	8	40525	Junquillo lateral		H - 203.4
8	40525	Junquillo superior / inferior		L/4 - 100.6	
2	03E0031	U marco		L-37	
Acristalamiento			L/4-116 x H-231.1		

Den.	Unidades	Referenc.	Descripción
Accesorios	32	1252700	Escuadra hoja
	32	0101500	Escuadra alineamiento 10 x1,5
	16	0101803	Escuadra alineamiento
	3	1770022	Kit elevable Elegance
	16	0000020	Grapa guía superior
	4	302264	Tapa salida de agua
Juntas	6 x metro	0000030	Clip fijación 1E3140
	2	0000080	Tapa 4 hojas 1E3135
	8H	0106575	Felpa TRI-FIN 6.5x7.5 negro
	4L + 8H	03E0032	Junta hoja
	2L + 8H		Junta acristalar (según vidrio)
	2L + 8H		Junta acristalar (según vidrio)
	4(H - 70.6)	P2776	Junta cruce

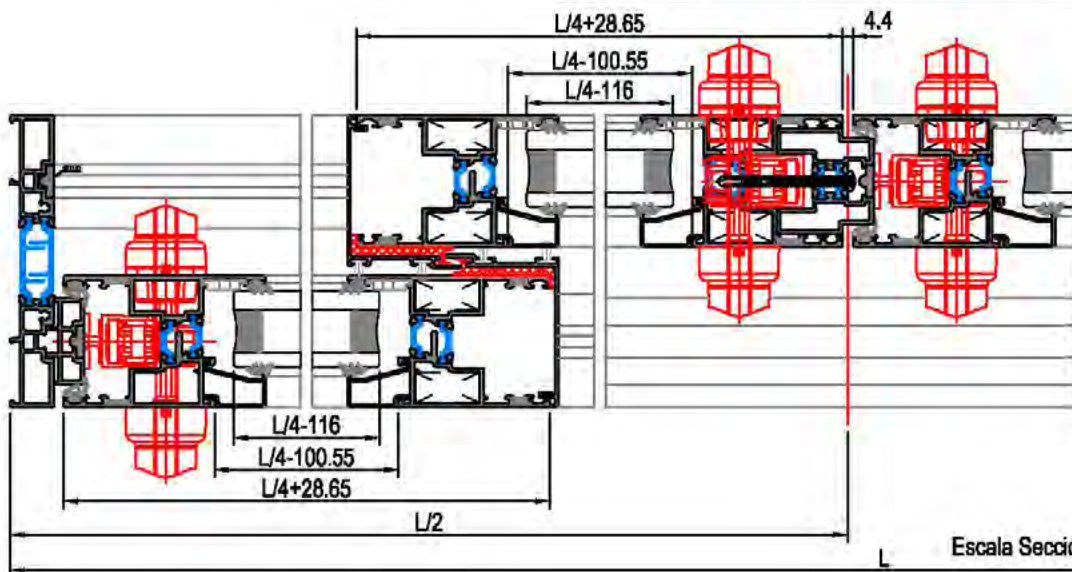

Escala Sección 1:3

ELEGANCE

Puerta corredera 1 hoja con fijo minimalista

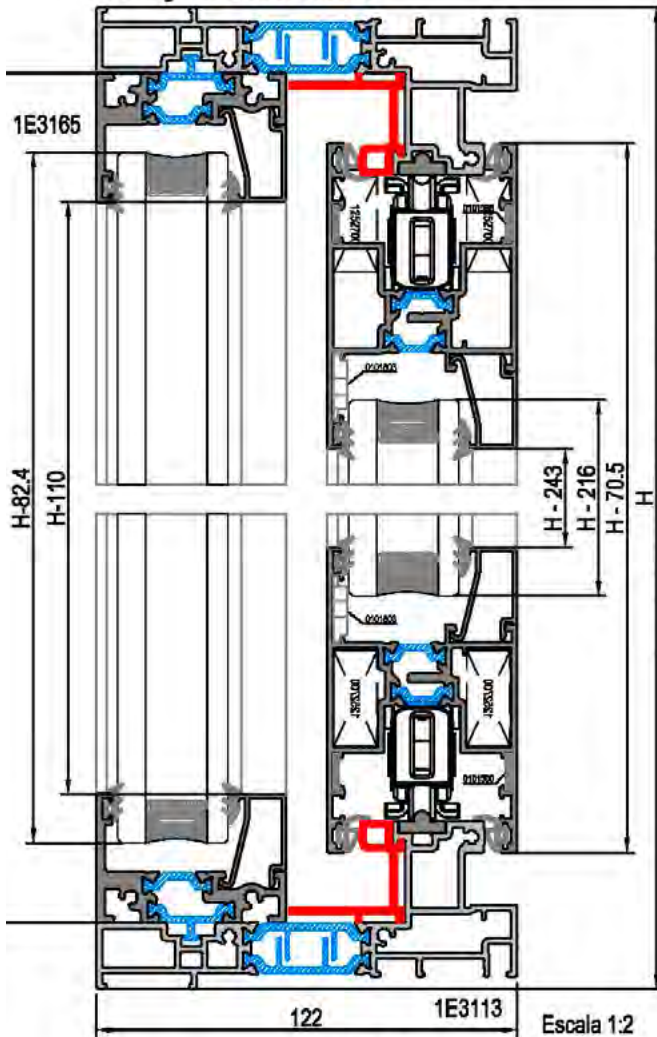
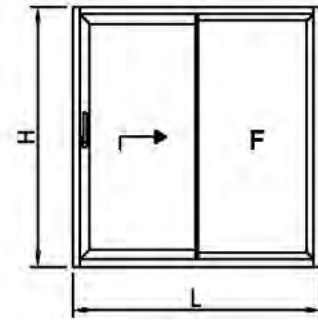

Den.	Und.	Referenc.	Descripción	Corte	Medidas
Marco	2	1E3110	Marco lateral		H
	2	1E3113	Marco superior / inferior		L - 37
	2	1E3165	Hoja lateral fijo		H - 37
Hoja	1	1E3165	Hoja lateral		H - 70.5
	2	1E3165	Hoja superior / inferior		L/2 + 18.3
	2	1E3165	Hoja superior / inferior fijo		L/2 + 18.3
	2	1E3170	Perfil de cruce		H - 70.5
	2	1E3160	Carril rodadura sup/inf.		L - 37
	2	40---	Junquillo lateral		H - 110
	2	40---	Junquillo superior / inferior		L/2 - 32.7
	2	40---	Junquillo lateral fijo		H - 243
Acristalamiento					

Den.	Undidades	Referenc.	Descripción
Accesorios	4	1252700	Escuadra hoja
	4	0101500	Escuadra alineamiento 10 x1,5
	2	0101803	Escuadra alineamiento
	1	1770022	Kit elevable Elegance
	8	0000020	Grapa guía superior
	2	302264	Tapa salida de agua
Juntas	6 x metro	0000030	Clip fijación 1E3140
	2H	0106575	Felpa TRI-FIN 6.5x7.5 negro
	4L + 4H	03E0032	Junta hoja
	2L + 4H		Junta acristalar (según vidrio)
	2L + 4H		Junta acristalar (según vidrio)

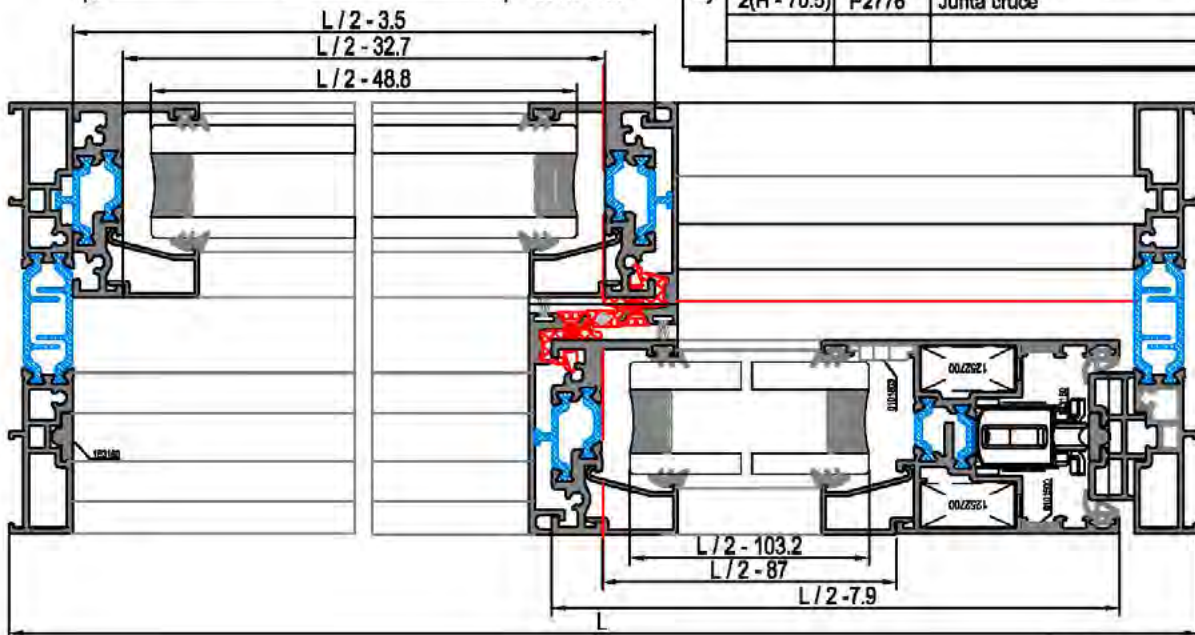

Escala Sección 1:2

Puerta corredera 1 hoja con fijo y marco minimalista

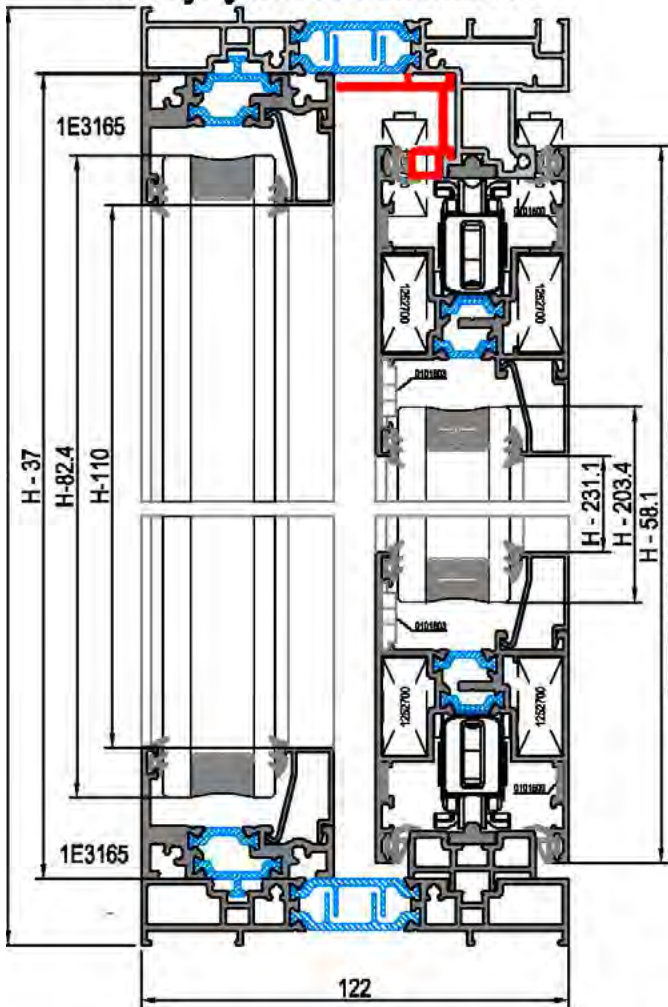
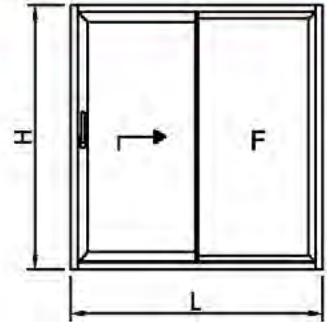

Escala 1:2

Den.	Und.	Referenc.	Descripción	Corte	Medidas
Marco	2	1E3110	Marco lateral	████████	H
	1	1E3113	Marco superior	████████	L - 37
	1	1E3110	Marco inferior	████████	L - 37
Hoja	2	1E3165	Hoja lateral fijo	████████	H - 37
	1	1E3165	Hoja lateral	████████	H - 58.1
	2	1E3165	Hoja superior / inferior	████████	L/2 - 7.9
	2	1E3165	Hoja superior / inferior fijo	████████	L/2 - 3.5
	1	1E3170	Perfil de cruce	████████	H - 58.1
	1	1E3170	Perfil de cruce fijo	████████	H - 37
	2	1E3160	Caril rodadura sup/inf.	████████	L - 37
	2	40—	Junquillo lateral	████████	H - 231.1
	2	40—	Junquillo superior / inferior	████████	L / 2 - 87
	2	40—	Junquillo lateral fijo	████████	H - 110
2	40—	Junquillo sup / inf fijo	████████	L / 2 - 32.7	
2	03E0031	U marco	████████	L-37	
Acristalamiento			L/2 - 48.8 x H-82.4 (1 Ud)		
			L/2 - 103.2 x H-203.4 (1 Ud)		

Den.	Undidades	Referenc.	Descripción
Accesorios	4	1252700	Escuadra hoja
	4	0101500	Escuadra alineamiento 10 x1,5
	2	0101803	Escuadra alineamiento
	1	1770022	Kit elevable Elegance
	8	0000020	Grapa guía superior
	2	302264	Tapa salida de agua
	6 x metro	0000030	Clip fijación 1E3140
Juntas	2H	0106575	Felpa TRI-FIN 6.5x7.5 negro
	4L + 4H	03E0032	Junta hoja
	2L + 4H		Junta acristalar (según vidrio)
	2L + 4H		Junta acristalar (según vidrio)
	2(H - 70.6)	P2776	Junta cruce

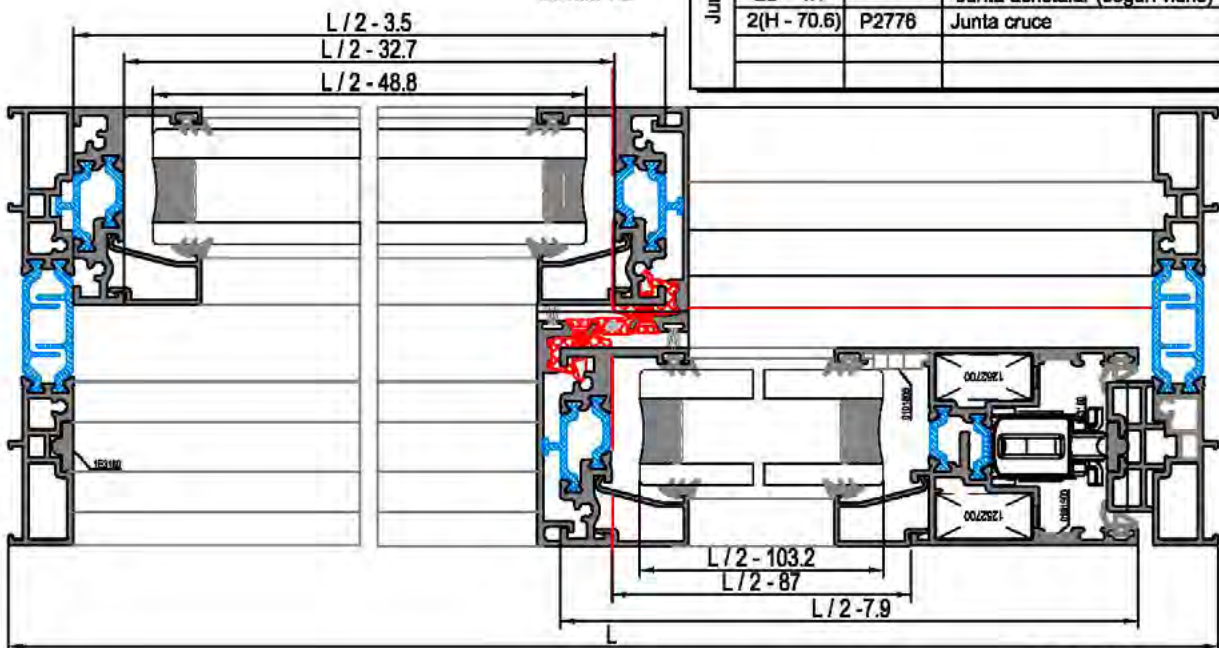

Escala 1:2

NOTAS

Carrer de l'Agricultura, 27
08840 Viladecans, BCN
93 637 75 12
alubaix@alubaix.com
www.alubaix.com

 @aluminiosdelbaix
@windthermic



*Distribuidor exclusivo de
Sistemas WindThermic*

